

GERDA[®]

PREMIUM DOOR MANUFACTURER



HOUSE DOORS

THERMO PRIME | THERMO PREMIUM | OPTIMA



OPEN DOORS WITH YOUR SMARTPHONE

Open and close doors and monitor door lock status from any place around the world. With the automatic opening feature, you don't need to take your phone out from your purse or pocket. The lock will detect your presence and let you in. The self-locking feature works based on the same principle.

HIGH-PERFORMANCE BATTERY

Gerda engineers, in collaboration with the South Korean Research Institute, have developed a small dedicated high-performance battery. It powers the mechanism for six months of operation. And when in need of recharging, the lock will let you know and you can charge the battery overnight.

SAFETY WARRANTY

The lock actuating mechanism is an innovative, patented design developed by Gerda engineers. The software was created by Tedee IoT experts. An intuitive app lets you keep track of who and when has locked or unlocked the door. It also offers a virtual key allocation feature.

SET*

TEDEE LOCK + TEDEE BRIDGE + CLASS 6 LOCK CYLINDERS



CLASS 6 LOCK CYLINDERS INCLUDED

- ✓ ANTI-BURGLARY TUMBLER LOCK INSERT. NEW LOCK INSERT DESIGN SECURED AGAINST 'LOCK BUMPING', WITH EFFECTIVE DRILL OPENING PROTECTION.



INSTALL A TEDEE LOCK

- ✓ SLIDE THE LOCK ONTO A GERDA INSERT, ADJUST THE LOCK POSITION AND SECURE IT WITH ONE BOLT. INSTALLATION TAKES NO MORE THAN TWO MINUTES. INSPECT TO SEE WHETHER THE BOLTS SLIDE UPON TURNING THE KNOB.



INSTALL THE SMARTPHONE APP

- ✓ DOWNLOAD THE TEDEE APP FROM APPLE STORE OR GOOGLE PLAY. SIGN UP AND ACTIVATE YOUR BLUE-TOOTH, LOCATION SERVICE AND INTERNET ACCESS. ADD YOUR LOCK AND ENTER THE ACTIVATION CODE.



CONNECT THE BRIDGE

- ✓ FIND A FREE POWER SOCKET NEXT TO THE TEDEE LOCK AND PLUG THE BRIDGE IN. THIS WILL ENABLE YOU TO CONTROL THE LOCK OVER THE INTERNET FROM WHEREVER YOU ARE.

WHAT SHOULD YOU KNOW ABOUT GERDA DOORS



THERMAL INSULATION

Heat transfer coefficient (Ud) indicates the amount of thermal energy passing through the door (including the door frame). Based on this coefficient, we are able to determine the heat loss for a given division. Even a slight loss translates to higher heating costs. The coefficient value depends on the type and thickness of the door's material. Gerda HOUSE DOORS comply with the current standards by using modern technologies and steel-wooden or aluminum door frames.

Gerda doors, depending on the components used, may have different insulation coefficient levels:

- insulation doors
- energy-saving doors
- passive doors

The basic doors in our offer, so-called insulation doors, have a coefficient below 1.3 W/m²K. The door frame used is a steel PERFOTHERM® frame with thermal perforation, a seal and sill.

Energy-saving Optima 60 and Thermo Premium 60 doors have a coefficient starting from 0.9 W/m²K with a warm aluminum ALUTHERM door frame (with thermal chamber filling and a seal) and 1.0 W/m²K with DUOTHERM (warm steel-wooden door frame with thermal perforation and seal).

Passive doors are primarily meant to ensure maximum conservation of energy, while increasing the comfort of living. They allow for energy accumulation in the room, which leads to direct savings. Thermo Premium 75 doors feature a heat transfer coefficient from 0.79 W/m²K. The heat transfer coefficient applies to solid doors with a warm aluminum ALUTHERM door frame.

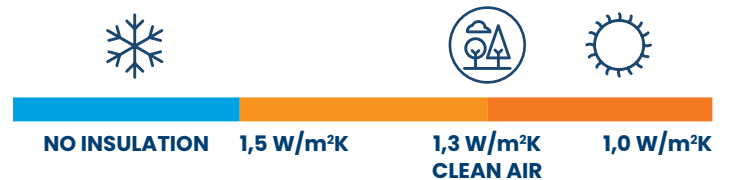

RESISTANCE TO BURGLARY

This parameter is decisive for the so-called anti-burglary doors. Such doors have a solid structure that significantly impedes the possibility to cut out an opening through the door, preventing unauthorized entrance. As a standard, GERDA doors are fitted with two robust locks with a multi-point bolting system. Their key element are anti-prizing bolts that prevent forcing the door leaf or lifting it off the hinges. GERDA doors are tested for resistance to burglary and hold an anti-burglary protection class from RC2/RC3 to RC3. The higher the class of doors installed, the greater the safety of people and property in the house.



ANTI-BURGLARY PROTECTION CLASSES

RC2 CLASS

- PLIERS
- WEDGE
- HAMMER

RC3 CLASS

- STEEL PRY BAR
- WEDGE
- HAMMER
- MECHANICAL DRILL

RC4 CLASS

- HEAVY HAMMER
- AXE
- CHISEL
- BIT
- HAMMER DRILL

WHAT SHOULD YOU REMEMBER WHEN SELECTING GERDA DOORS

1

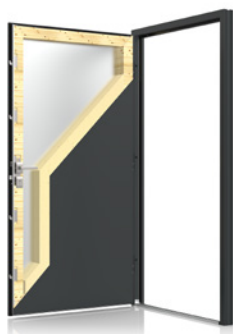

DECIDE ON A DOOR STRUCTURE TAILORED TO YOUR NEEDS

2



CHOOSE THE DESIGN

3

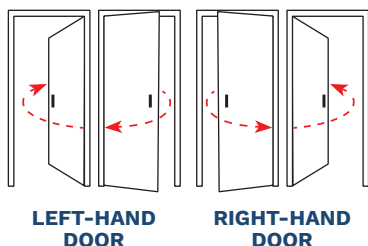

CHECK THE AVAILABLE SIZES

4



CREATE YOUR OWN, INDIVIDUAL DESIGN BY CHOOSING VENEER PATTERNS, GLAZING AND INSERTS

5



SELECT OPTIONAL ACCESSORIES: GLAZED SIDE AND TOP PANELS, HANDLES, HANDRAILS, DOOR FRAMES



**MILANO 8
WINCHESTER**



**VILLACH
STEEL GRAY**



**INNSBRUCK
LIGHT WALNUT**



REGEN 5
DARK ANTHRACITE









BAMBERG 3
TURNER OAK

GERDA® THERMO PRIME 75



PARAMETERS

	THERMAL INSULATION U ₀ VALUES FOR INWARD-OPENING REFERENCE DOORS	ALUTHERM 75 DOOR FRAME SOLID DOOR 0,79 W/m²K GLAZED DOOR 0,9 W/m²K
	ANTI-BURGLARY PROTECTION CLASS	RC2
	LEAF THICKNESS	75 mm
	DOOR SIZES	80, 90N, 90E, 100E*
	DESIGN LINES	4
	LEAF STRUCTURE	WOODEN FRAME + PUR FOAM
	CUSTOM-SIZE DOOR	DOOR HEIGHT UP TO 2400 mm

**ALUTHERM 75 DOOR FRAME
SOLID DOOR / GLAZED DOOR**

**STEEL DOOR FRAME
SOLID DOOR / GLAZED DOOR**

$U_D = 0,79 / 0,9 \text{ W/m}^2\text{K}$

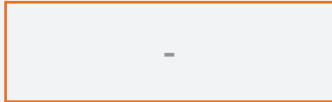

RC2



Adjustable hook hitches with flexible teflon insert

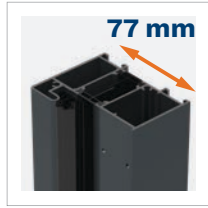

ALUTHERM 75 door frame



Hinges adjustable in three planes with caps matching fitting's colour



Adjustable pawl hitch

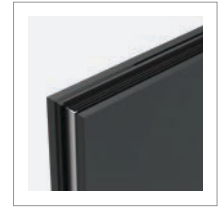

Door leaf with thermal division



Mortise lock: 5 point hooked or 3 point automatic



Handles with long or split escutcheon



Ring escutcheon*



Composite connector of threshold

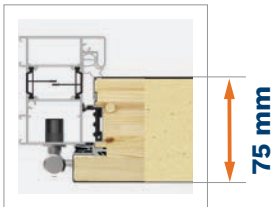

ALUTHERM 75 door frame

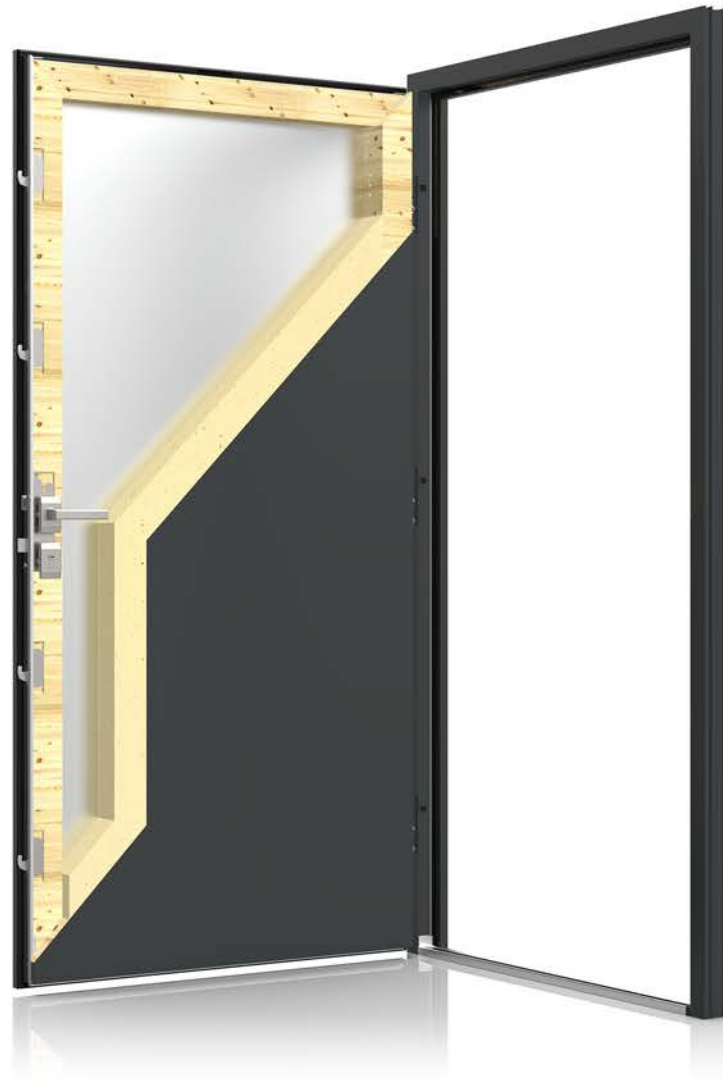

Lower upstand brush seal PRIME



Fixed anti-prizing bolts



Warm aluminium subthreshold extension



GERDA RESIST ULTRA insulation duo tapes*



Tedee lock + tedee bridge*



4 sides rebated



Class 5 lock cylinder (5 keys + installer's keys)

GERDA® THERMO PREMIUM 75



PARAMETERS

UD	THERMAL INSULATION U _D VALUES FOR INWARD-OPENING RÉFÉRENCE DOORS	ALUTHERM 75* DOOR FRAME SOLID DOOR 0,79 W/m²K GLAZED DOOR 1,1 W/m²K	DUOTHERM 75 DOOR FRAME SOLID DOOR 0,87 W/m²K GLAZED DOOR 1,3 W/m²K
RC	ANTI-BURGLARY PROTECTION CLASS		RC2 / RC3**
	LEAF THICKNESS		75 mm
	DOOR SIZES		80, 90N, 90E, 100E*
	DESIGN LINES		4
	LEAF STRUCTURE	WOODEN FRAME + EXPANDED GRAPHITE POLYSTYRENE	

**ALUTHERM 75* DOOR FRAME
SOLID DOOR / GLAZED DOOR**

**DUOTHERM 75 DOOR FRAME
SOLID DOOR / GLAZED DOOR**

$U_D = 0,79 / 1,1 \text{ W/m}^2\text{K}$

$U_D = 0,87 / 1,3 \text{ W/m}^2\text{K}$

RC2 / RC3**



Vertical bolt*



DUOTHERM 75 door frame



Hinges adjustable in three planes with caps matching fitting's colour

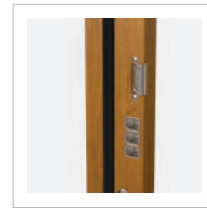

Adjustable pawl hitch



Door leaf with thermal division



Auxiliary 3-bolt lock



Main 3-bolt lock



Class 5 lock cylinder, single key system (5 keys + installer's keys)



Auxiliary 2-bolt lock

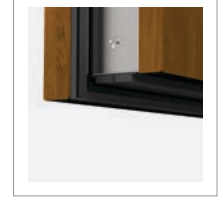

Lower upstand brush seal



Fixed anti-prizing bolts



Subthreshold extension*
DUOTHERM 75 – option
ALUTHERM 75 – standard



GERDA RESIST ULTRA insulation duo tapes*



ALUTHERM 75* door frame



DUOTHERM 75 door frame



4 sides rebated



Tede lock + tede bridge*

GERDA® THERMO PREMIUM 60



PARAMETERS

UD	THERMAL INSULATION U _D VALUES FOR INWARD-OPENING REFERENCE DOORS	ALUTHERM 60* DOOR FRAME SOLID DOOR 0,86 W/m²K GLAZED DOOR 1,2 W/m²K	DUOTHERM 60 DOOR FRAME SOLID DOOR 0,94 W/m²K GLAZED DOOR 1,3 W/m²K
RC	ANTI-BURGLARY PROTECTION CLASS		RC2 / RC3**
	LEAF THICKNESS		60 mm
	DOOR SIZES		80, 90N, 90E, 100E*
	DESIGN LINES		4
	LEAF STRUCTURE	WOODEN FRAME + EXPANDED GRAPHITE POLYSTYRENE	

**ALUTHERM 60* DOOR FRAME
SOLID DOOR / GLAZED DOOR**

**DUOTHERM 60 DOOR FRAME
SOLID DOOR / GLAZED DOOR**

$U_D = 0,86 / 1,2 \text{ W/m}^2\text{K}$

$U_D = 0,94 / 1,3 \text{ W/m}^2\text{K}$

RC2 / RC3**



Vertical bolt*



DUOTHERM 60
door frame



Hinges adjustable in three
planes with caps matching
fitting's colour



Adjustable pawl
hitch



Auxiliary 3-bolt lock

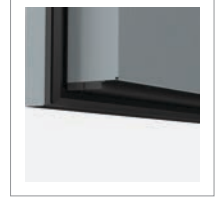

Lower upstand
brush seal



Main 3-bolt lock



Fixed anti-prizing
bolts



Class 5 lock cylinder,
single key system
(5 keys + installer's keys)



Subthreshold
extension*
DUOTHERM 60 –
option
ALUTHERM 60 –
standard

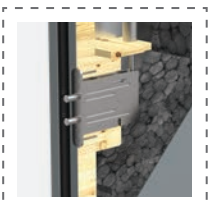

Auxiliary 2-bolt lock*



GERDA RESIST
ULTRA insulation
duo tapes*

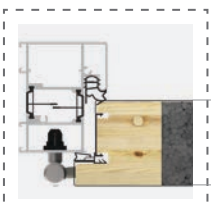
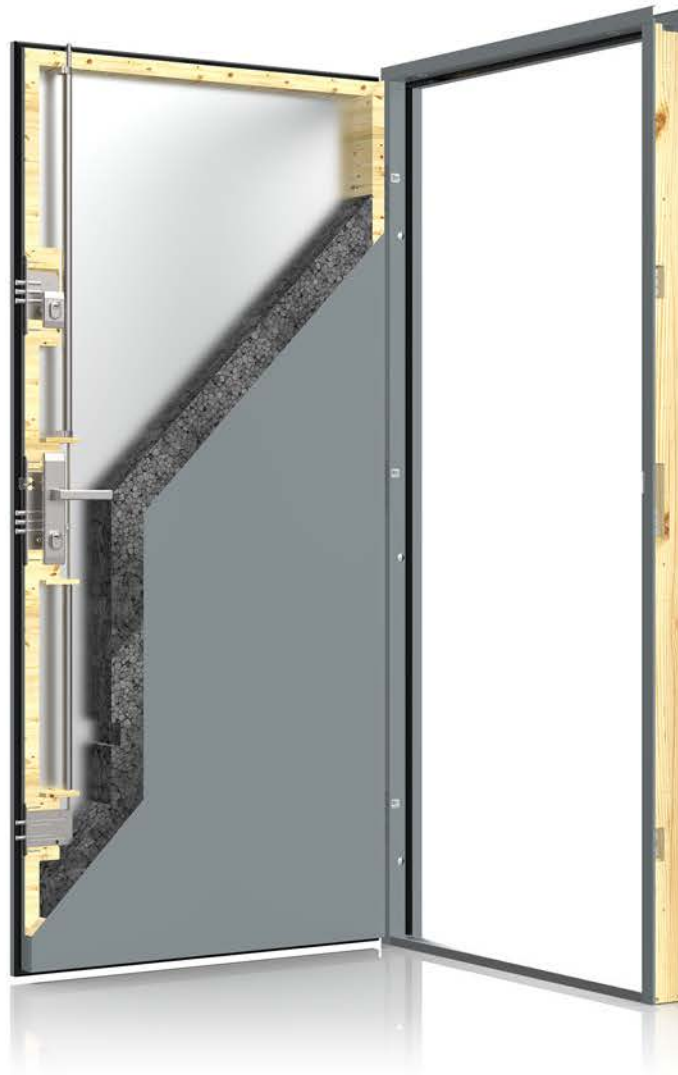

ALUTHERM 60*
door frame



DUOTHERM 60
door frame



4 sides rebated



Tedee lock
+ tedee bridge*

AIR GLASS



AGB LINZ 1 p. 26



AGC LINZ 2 p. 26



AGD LINZ 3 p. 26



AGDB LINZ 3 B p. 26



AGE GRAZ 1 p. 28



AGF GRAZ 2 p. 28



AGG GRAZ 3 p. 29

QUARDO

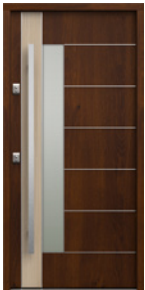

KWA PASAWA 1 p. 32



KWB PASAWA 2 p. 32



KWC PASAWA 3 p. 33



KWD PASAWA 4 p. 33



KWE JENA 3 p. 34

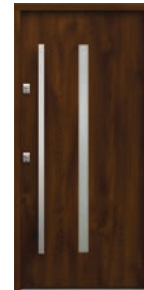

KW4 JENA 4 p. 34



KWF BAMBERG 1 p. 36

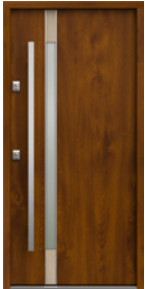

KWN TREWIR 3 p. 41



KWP TREWIR 4 p. 41

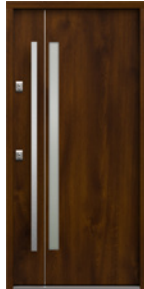

KW7 TREWIR 7 p. 41



KWS DORFEN p. 42



KWT KASSEL 1 p. 44



KWX KASSEL 2 p. 44



KPN KRONACH 1 p. 46



KPM REGEN 5 p. 49



KPR REGEN 6 p. 49

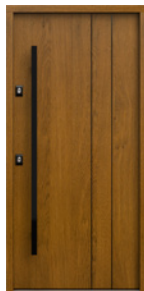

KPRB REGEN 6 B p. 49

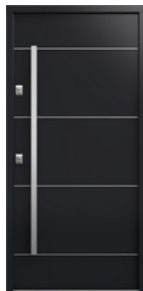

KPE DREZNO 1 p. 50



KPF DREZNO 2 p. 50

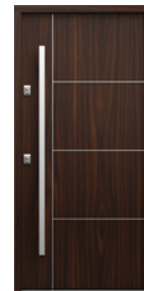

KPH DREZNO 4 p. 51



KPA ERFURT 1 p. 52

ELITE 3D



ELA BRIG p. 54



ELB OLTEN p. 54



ELC VISP p. 55



ELD TRIN p. 55



ELE BERNO p. 55



NS1 MILANO 8 p. 56



NS2 MILANO 9 p. 56

TEMPO

AIR GLASS



AGGB GRAZ 3 B p. 29



AGA SALZBURG p. 30



AGH VILLACH p. 30



AGHB VILLACH B p. 30

QUARDO



KWG BAMBERG 2 p. 36



KWH BAMBERG 3 p. 37



KWI BAMBERG 4 p. 37

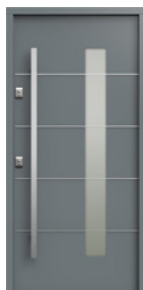

KWJ ULM 1 p. 38



KWK ULM 2 p. 38



KWL TREWIR 1 p. 40



KWM TREWIR 2 p. 40



KPP KRONACH 2 p. 46



KPT KRONACH 3 p. 47



KPZ KRONACH 4 p. 47



KPJ REGEN 1 p. 48



KPK REGEN 2 p. 48



KPL REGEN 3 p. 49



KPS REGEN 4 p. 49



KPB ERFURT 2 p. 52



KPC ERFURT 3 p. 53

TEMPO



NS3 MILANO 10 p. 57



NS4 MILANO 11 p. 57



NS9B MILANO 12 B p. 57

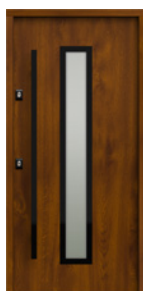

NSSB HANOVER 5 B p. 58



NS6 HANOVER 6 p. 58



NS7 INNSBRUCK p. 59



W00 PŁASKIE p. 60



PARAMETERS

UD	THERMAL INSULATION U _D VALUES FOR INWARD-OPENING REFERENCE DOORS	ALUTHERM 60* DOOR FRAME SOLID DOOR 1,0 W/m²K GLAZED DOOR 1,3 W/m²K	PERFOTHERM 60 DOOR FRAME SOLID DOOR 1,1 W/m²K GLAZED DOOR 1,3 W/m²K
RC	ANTI-BURGLARY PROTECTION CLASS	RC2 / RC3**	
	LEAF THICKNESS	60 mm	
	DOOR SIZES	80N, 80, 90N, 90E, 100E*	
	DESIGN LINES	2	
	LEAF STRUCTURE	WOODEN FRAME + EXPANDED GRAPHITE POLYSTYRENE	

**ALUTHERM 60* DOOR FRAME
SOLID DOOR / GLAZED DOOR**

**PERFOTHERM 60 DOOR FRAME
SOLID DOOR / GLAZED DOOR**

$U_D = 1,0 / 1,3 \text{ W/m}^2\text{K}$

$U_D = 1,1 / 1,3 \text{ W/m}^2\text{K}$

RC2 / RC3**



Vertical bolt*

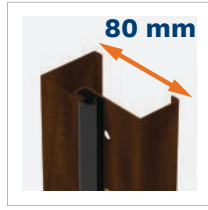

PERFOTHERM 60 door frame



Hinges adjustable in two planes with caps matching fitting's colour



Adjustable pawl hitch



Auxiliary 3-bolt lock



Main 3-bolt lock



Class 5 lock cylinder, single key system (5 keys + installer's keys)



Auxiliary 2-bolt lock*

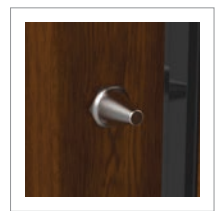

Fixed anti-prizing bolts



Subthreshold extension*
PERFOTHERM 60 – option
ALUTHERM 60 – standard



GERDA RESIST ULTRA insulation duo tapes*



ALUTHERM 60* door frame

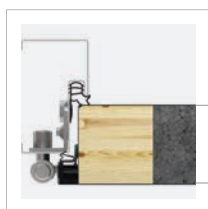

PERFOTHERM 60 door frame



3 sides rebated









Tedee lock + tedee bridge*

GERDA® OPTIMA 50



PARAMETERS

	THERMAL INSULATION U_0 VALUES FOR INWARD-OPENING REFERENCE DOORS	PERFOTHERM 50* DOOR FRAME SOLID DOOR 1,2 W/m²K
	ANTI-BURGLARY PROTECTION CLASS	RC2
	LEAF THICKNESS	50 mm
	DOOR SIZES	80N, 80, 90N, 90E, 100E*
	DESIGN LINES	2
	LEAF STRUCTURE	WOODEN BLOCKS + WOODEN FRAME + EXPANDED GRAPHITE POLYSTYRENE

ALUMINUM DOOR FRAME
SOLID DOOR / GLAZED DOOR



PERFOTHERM 50* DOOR FRAME
SOLID DOOR

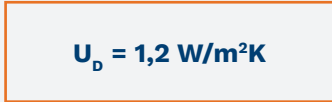

FB
steel door frame

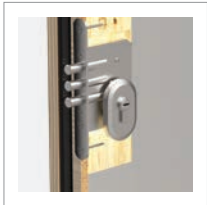

Auxiliary 3-bolt lock

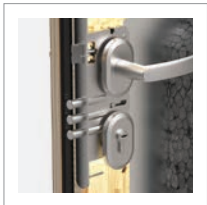

Main 3-bolt lock



Class 5 lock cylinder,
single key system
(5 keys + installer's keys)

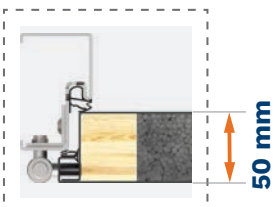

PERFOTHERM 50*
door frame

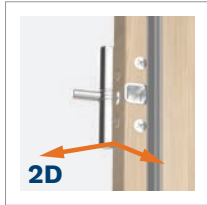

Hinges adjustable
in two planes with
caps matching
fitting's colour

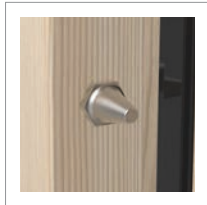

Fixed anti-prizing
bolts

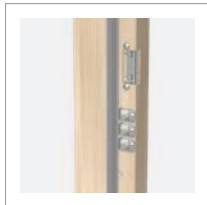

Adjustable pawl
hitch



Tedee lock
+ tedee bridge*

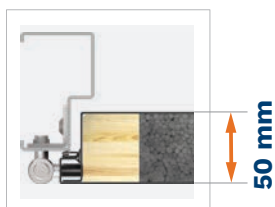

FB
door frame

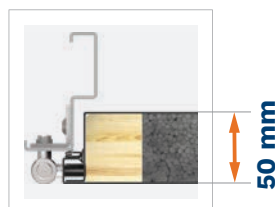

FN
door frame

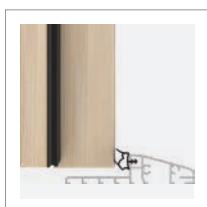

3 sides rebated

TEMPO



NS1 MILANO 8 p. 56



NS2 MILANO 9 p. 56



NS3 MILANO 10 p. 57



NS4 MILANO 11 p. 57



NS9 MILANO 12 p. 57



NS9B MILANO 12 B p. 57



NS5 HANOVER 5 p. 58



NT1 TURYN 1 p. 64



NT2 TURYN 2 p. 65



SOJ BERGAMO 2 p. 66



SJ9 NICEA 9 p. 66



SBE BERLIN 4 p. 67

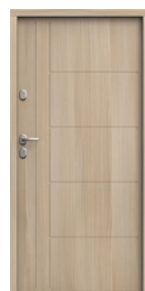

ST4 UPPSALA 1 p. 68



ST4A UPPSALA 1A p. 68



ST9 LUND 1 p. 72



WBA ASPEN 1 p. 73



TN7 ASPEN 2 p. 73



TN7B ASPEN 2B p. 73



SR3 TROMSO 1 p. 74

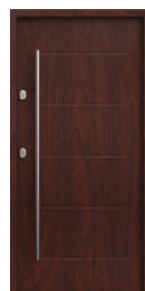

SR4 TROMSO 1 p. 74



SR5 TROMSO 2 p. 75

CLASSIC



W76 MODENA p. 76



W77 MODENA 2 p. 76



W78 MODENA 3 p. 77

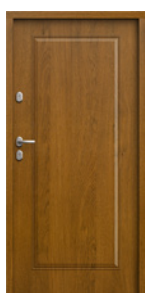

WDR RAVENA p. 77



WJ1 NICEA 5 p. 78



W23 OLYMPIA p. 79



W91 WERONA p. 80



W24 LIZBONA p. 82



W9N WENECJA p. 82



W13 LONDYN p. 83



W5L LONDYN 1 p. 83



W54 BARCELONA p. 84



W53 BARCELONA 1 p. 84



G76 GENEWA 1 p. 85

TEMPO



NS5B HANOVER 5 B p. 58



NS6 HANOVER 6 p. 58



NS7 INNSBRUCK p. 59



W00 PLAIN p. 60



W00 PLAIN p. 60



SNU MILANO 4 p. 62

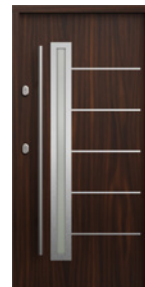

SNUA MILANO 4A p. 62

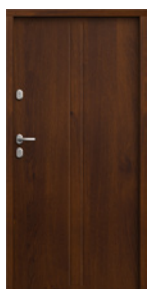

TML TOKIO 1 p. 70



TMLA TOKIO 1A p. 70



TMM TOKIO 2 p. 71



TMMa TOKIO 2A p. 71



ST8 RYGA p. 72



SR5 TROMSO 2 p. 75

CLASSIC



W94 WERONA 1 p. 80



W93 WERONA 3 p. 81



W6A WERONA 4 p. 81



WQA WERONA 5 p. 81



G75 GENEWA 2 p. 85



D75 GENEWA 3 p. 85

AIR GLASS LINZ

GERDA®



AGB LINZ 1



AGC LINZ 2

Door size	80	90N	90E	100E
Door height (DUOTHERM / ALUTHERM)	2076 / 2087 mm			

MODEL	THERMO PREMIUM 60	THERMO PREMIUM 75	THERMO PRIME 75
AGB LINZ 1 / AGBB LINZ 1 B	✓	✓	✓
AGC LINZ 2 / AGCB LINZ 2 B	✓	✓	✓
AGD LINZ 3 / AGDB LINZ 3 B	✓	✓	✓

RC2 STANDARD EQUIPMENT

- GLAZED DOOR LEAF
- 4 SIDES REBATED
- THERMO PREMIUM – DUOTHERM DOOR FRAME
- THERMO PRIME – ALUTHERM 75 DOOR FRAME
- HINGES ADJUSTABLE IN THREE PLANES WITH CAPS MATCHING FITTING'S COLOUR
- INSERTS **INOX** **BLACK**
- WARM THRESHOLD
- FITTINGS SET WITH LOCK CYLINDER PROTECTION
- BERGEN ESCUTCHEONS WITH ALEX HANDLES
- THERMO PREMIUM – CLASS 5 LOCK CYLINDER, SINGLE KEY SYSTEM, BOLT LOCK
- THERMO PRIME – CLASS 5 LOCK CYLINDER, 3 POINT HOOKED MORTISE LOCK OR 5 POINT AUTOMATIC MORTISE LOCK

EXTRA CHARGES

ALUTHERM DOOR FRAME (THERMO PREMIUM DOOR)	ROSTOCK HANDRAIL	2000 mm
TWO-COLOUR DOOR		1800 mm
CLASS 6 LOCK CYLINDERS, SINGLE KEY SYSTEM	AMSTERDAM / MONTREAL HANDRAIL	1700 mm
	ELECTRIC STRIKE RECOMMENDED	1500 mm
		1000 mm
UPPER ESCUTCHEON PROTECTION (THERMO PREMIUM)		1800 mm
KNOB-HANDLE	AMSTERDAM / MONTREAL HANDRAIL WITH PUSHBUTTON, WITH DOOR LEAF ADJUSTMENT AND ELECTRIC STRIKE	1700 mm
REED SWITCH		1500 mm
SIZE 100E		1000 mm
INTEGRATED CLOSER	AMSTERDAM HANDRAIL WITH WIRELESS PUSHBUTTON	1700 mm
	ELECTRIC STRIKE NECESSARY	1500 mm
ELECTRIC STRIKE WITH DAY / NIGHT FEATURE	TEDEE SET	

FIXED GLAZED SIDE PANELS: PAGES 88–89, FULL EQUIPMENT LIST: PAGES 94–99

GLASS

AIR GLASS



INSERT

INOX



BLACK



DOOR COLOURS

ALPINE WALNUT

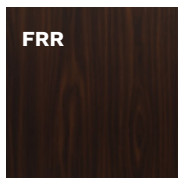

MAHOGANY

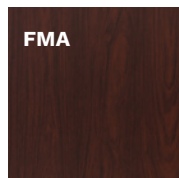

BRAZILIAN WALNUT

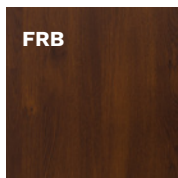

LIGHT WALNUT

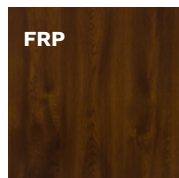

GOLDEN OAK

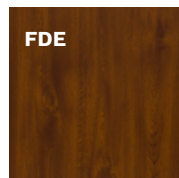

WINCHESTER

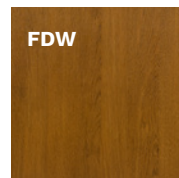

TURNER OAK





AGD LINZ 3



INTERNAL SIDE

THERMO PRIME 75 DOOR CONFIGURATION



AGDB LINZ 3 B



INTERNAL SIDE

FITTINGS

HANDLE-HANDLE



THERMO
PRIME

SOFIA



BERGEN

THERMO
PREMIUM



BERGEN

KNOB-HANDLE*

THERMO
PRIME



BERGEN

THERMO
PREMIUM



BERGEN

HANDRAIL-HANDLE*

THERMO PRIME
THERMO PREMIUM

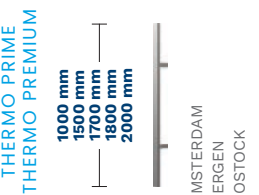

AMSTERDAM
BERGEN
ROSTOCK

FITTINGS' COLOURS

PLATINUM ANODE

SILVER ANODE

BLACK ANODE

DOOR COLOURS

LIGHT WENGE



FEJ

WHITE



FSB

STEEL GRAY

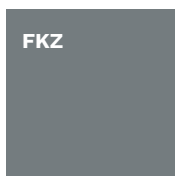

FKZ

ANTHRACITE

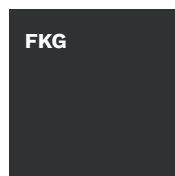

FKG

DARK ANTHRACITE

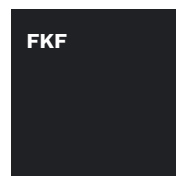

FKF

BLACK



FKC

TWO-COLOUR DOOR*

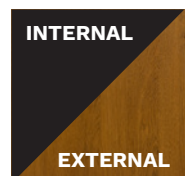

INTERNAL

EXTERNAL

* EXTRA CHARGE

AIR GLASS GRAZ

GERDA®



AGE GRAZ 1



AGF GRAZ 2

Door size	80	90N	90E	100E
Door height (DUOTHERM / ALUTHERM)	2076 / 2087 mm			

MODEL	THERMO PREMIUM 60	THERMO PREMIUM 75	THERMO PRIME 75
AGE GRAZ 1 / AGEB GRAZ 1 B	✓	✓	✓
AGF GRAZ 2 / AGFB GRAZ 2 B	✓	✓	✓
AGG GRAZ 3 / AGGB GRAZ 3 B	✓	✓	✓

RC2 STANDARD EQUIPMENT

- GLAZED DOOR LEAF
- 4 SIDES REBATED
- THERMO PREMIUM – DUOTHERM DOOR FRAME
- THERMO PRIME – ALUTHERM 75 DOOR FRAME
- HINGES ADJUSTABLE IN THREE PLANES WITH CAPS MATCHING FITTING'S COLOUR
- INSERTS INOX BLACK
- WARM THRESHOLD
- FITTINGS SET WITH LOCK CYLINDER PROTECTION
- BERGEN ESCUTCHEONS WITH ALEX HANDLES
- THERMO PREMIUM – CLASS 5 LOCK CYLINDER, SINGLE KEY SYSTEM, BOLT LOCK
- THERMO PRIME – CLASS 5 LOCK CYLINDER, 3 POINT HOOKED MORTISE LOCK OR 5 POINT AUTOMATIC MORTISE LOCK

EXTRA CHARGES

ALUTHERM DOOR FRAME (THERMO PREMIUM DOOR)	ROSTOCK HANDRAIL	2000 mm
		1800 mm
TWO-COLOUR DOOR	AMSTERDAM / MONTREAL HANDRAIL	1700 mm
	ELECTRIC STRIKE RECOMMENDED	1500 mm
CLASS 6 LOCK CYLINDERS, SINGLE KEY SYSTEM		1000 mm
		1800 mm
UPPER ESCUTCHEON PROTECTION (THERMO PREMIUM)	AMSTERDAM / MONTREAL HANDRAIL WITH PUSHBUTTON, WITH DOOR LEAF ADJUSTMENT AND ELECTRIC STRIKE	1700 mm
KNOB-HANDLE		1500 mm
REED SWITCH		1000 mm
SIZE 100E	AMSTERDAM HANDRAIL WITH WIRELESS PUSHBUTTON	1700 mm
INTEGRATED CLOSER	ELECTRIC STRIKE NECESSARY	1500 mm
ELECTRIC STRIKE WITH DAY / NIGHT FEATURE	TEDEE SET	

FIXED GLAZED SIDE PANELS: PAGES 88–89, FULL EQUIPMENT LIST: PAGES 94–99

GLASS

AIR GLASS

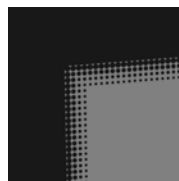

INSERT

INOX



BLACK



DOOR COLOURS

ALPINE WALNUT

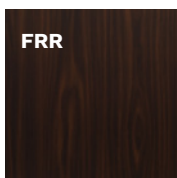

FRR

MAHOGANY

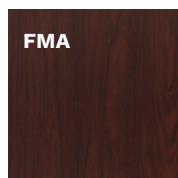

FMA

BRAZILIAN WALNUT

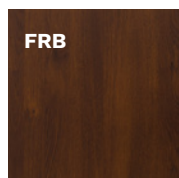

FRB

LIGHT WALNUT

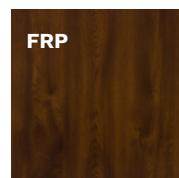

FRP

GOLDEN OAK

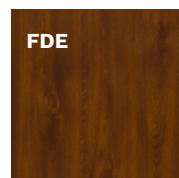

FDE

WINCHESTER

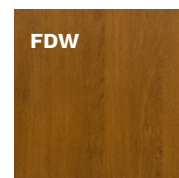

FDW

TURNER OAK



FDT



AGGB GRAZ 3 B



INTERNAL SIDE

THERMO PRIME 75 DOOR CONFIGURATION



AGF GRAZ 2



INTERNAL SIDE

FITTINGS

HANDLE-HANDLE



THERMO
PRIME

SOFIA



THERMO
PREMIUM

BERGEN

KNOB-HANDLE*



THERMO
PRIME

BERGEN



THERMO
PREMIUM

BERGEN

HANDRAIL-HANDLE*

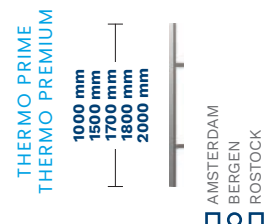

THERMO PRIME
THERMO PREMIUM

1000 mm
1500 mm
1700 mm
1800 mm
2000 mm

AMSTERDAM
BERGEN
ROSTOCK

FITTINGS' COLOURS

PLATINUM ANODE

SILVER ANODE

BLACK ANODE

DOOR COLOURS

LIGHT WENGE



FEJ

WHITE



FSB

STEEL GRAY

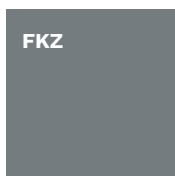

FKZ

ANTHRACITE

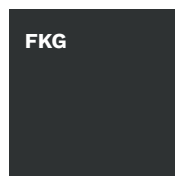

FKG

DARK ANTHRACITE

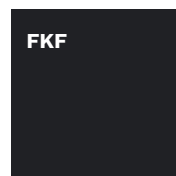

FKF

BLACK

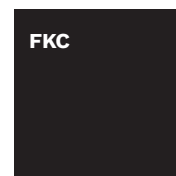

FKC

TWO-COLOUR DOOR*



INTERNAL

EXTERNAL

* EXTRA CHARGE

AIR GLASS SALZBURG / VILLACH

GERDA®



AGA SALZBURG



AGHB VILLACH B

Door size (SALZBURG)	80	90N	90E	100E
Door size (VILLACH)	-	-	90E	100E
Door height (SALZBURG) (DUOTHERM / ALUTHERM)	2076 / 2087 mm			
Door height (VILLACH) (DUOTHERM / ALUTHERM)	2076 / 2087-2400 mm			

MODEL	THERMO PREMIUM 60	THERMO PREMIUM 75	THERMO PRIME 75
AGA SALZBURG / AGAB SALZBURG B	✓	✓	✓
AGH VILLACH / AGHB VILLACH B	✓	✓	✓

RC2 STANDARD EQUIPMENT

• GLAZED DOOR LEAF	• WARM THRESHOLD
• 4 SIDES REBATED	• FITTINGS SET WITH LOCK CYLINDER PROTECTION
• THERMO PREMIUM – DUOTHERM DOOR FRAME	• BERGEN ESCUTCHEONS WITH ALEX HANDLES
• THERMO PRIME – ALUTHERM 75 DOOR FRAME	• THERMO PREMIUM – CLASS 5 LOCK CYLINDER, SINGLE KEY SYSTEM, BOLT LOCK
• HINGES ADJUSTABLE IN THREE PLANES WITH CAPS MATCHING FITTING'S COLOUR	• THERMO PRIME – CLASS 5 LOCK CYLINDER, 3 POINT HOOKED MORTISE LOCK OR 5 POINT AUTOMATIC MORTISE LOCK
• INSERTS	<div style="display: flex; gap: 10px;"> <div style="background-color: #cccccc; padding: 5px; border: 1px solid black;">INOX</div> <div style="background-color: #333333; color: white; padding: 5px; border: 1px solid black;">BLACK</div> </div>

EXTRA CHARGES

ALUTHERM DOOR FRAME (THERMO PREMIUM DOOR)	ROSTOCK HANDRAIL	2000 mm
TWO-COLOUR DOOR		1800 mm
CLASS 6 LOCK CYLINDERS, SINGLE KEY SYSTEM	AMSTERDAM / MONTREAL HANDRAIL	1700 mm
	ELECTRIC STRIKE RECOMMENDED	1500 mm
		1000 mm
UPPER ESCUTCHEON PROTECTION (THERMO PREMIUM)		1800 mm
	AMSTERDAM / MONTREAL HANDRAIL WITH PUSHBUTTON, WITH DOOR LEAF ADJUSTMENT AND ELECTRIC STRIKE	1700 mm
KNOB-HANDLE		1500 mm
REED SWITCH		1000 mm
SIZE 100E	AMSTERDAM HANDRAIL WITH WIRELESS PUSHBUTTON	1700 mm
INTEGRATED CLOSER	ELECTRIC STRIKE NECESSARY	1500 mm
ELECTRIC STRIKE WITH DAY / NIGHT FEATURE	TEDEE SET	

FIXED GLAZED SIDE PANELS: PAGES 88-89, FULL EQUIPMENT LIST: PAGES 94-99

GLASS

AIR GLASS

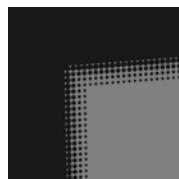

INSERT

INOX



BLACK



DOOR COLOURS

ALPINE WALNUT

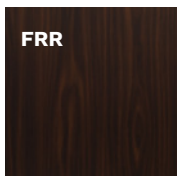

FRR

MAHOGANY

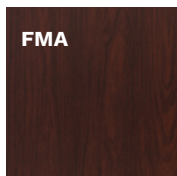

FMA

BRAZILIAN WALNUT

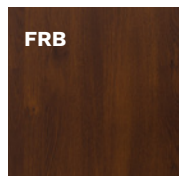

FRB

LIGHT WALNUT

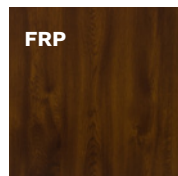

FRP

GOLDEN OAK

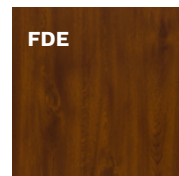

FDE

WINCHESTER

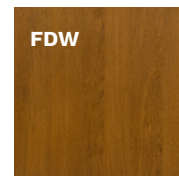

FDW

TURNER OAK



FDT



AGA SALZBURG



INTERNAL SIDE

THERMO PRIME 75 DOOR CONFIGURATION

FITTINGS

HANDLE-HANDLE

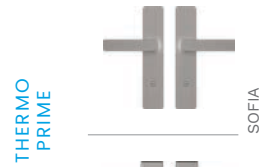

THERMO
PRIME

SOFIA



THERMO
PREMIUM

BERGEN

KNOB-HANDLE*



THERMO
PRIME

BERGEN



THERMO
PREMIUM

BERGEN

HANDRAIL-HANDLE*

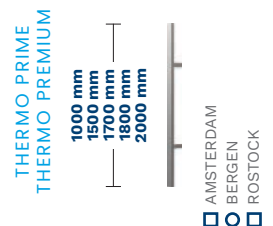

THERMO PRIME
THERMO PREMIUM

1000 mm
1500 mm
1700 mm
1800 mm
2000 mm

AMSTERDAM
BERGEN
ROSTOCK

FITTINGS' COLOURS

PLATINUM ANODE

SILVER ANODE

BLACK ANODE

DOOR COLOURS

LIGHT WENGE



WHITE



STEEL GRAY



ANTHRACITE

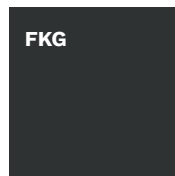

DARK ANTHRACITE

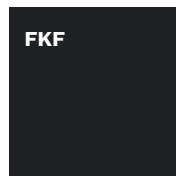

BLACK

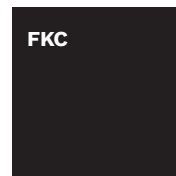

TWO-COLOUR DOOR*



* EXTRA CHARGE



KWA PASAWA 1



KWB PASAWA 2

Door size	80	90N	90E	100E
Door height (DUOTHERM / ALUTHERM)	2076 / 2087-2400 mm			

MODEL	THERMO PREMIUM 60	THERMO PREMIUM 75	THERMO PRIME 75
KWA PASAWA 1 / KWAB PASAWA 1 B	✓	✓	✓
KWB PASAWA 2 / KWBB PASAWA 2 B	✓	✓	✓
KWC PASAWA 3 / KWCB PASAWA 3 B	✓	✓	✓
KWD PASAWA 4 / KWDB PASAWA 4 B	✓	✓	✓

RC2 STANDARD EQUIPMENT

- GLAZED DOOR LEAF
- 4 SIDES REBATED
- THERMO PREMIUM – DUOTHERM DOOR FRAME
- THERMO PRIME – ALUTHERM 75 DOOR FRAME
- HINGES ADJUSTABLE IN THREE PLANES WITH CAPS MATCHING FITTING'S COLOUR
- WARM THRESHOLD
- FITTINGS SET WITH LOCK CYLINDER PROTECTION
- BERGEN ESCUTCHEONS WITH ALEX HANDLES
- THERMO PREMIUM – CLASS 5 LOCK CYLINDER, SINGLE KEY SYSTEM, BOLT LOCK
- THERMO PRIME – CLASS 5 LOCK CYLINDER, 3 POINT HOOKED MORTISE LOCK OR 5 POINT AUTOMATIC MORTISE LOCK

- INSERTS INOX BLACK

EXTRA CHARGES

CUSTOM HEIGHT (THERMO PRIME)	2150 - 2200 mm
AVAILABLE COLOURS: FRP, FDE, FDW, FKG, FKF	2250 - 2300 mm
	2350 - 2400 mm
ALUTHERM DOOR FRAME (THERMO PREMIUM DOOR)	ROSTOCK HANDRAIL 2000 mm
TWO-COLOUR DOOR	AMSTERDAM / MONTREAL HANDRAIL 1800 mm
CLASS 6 LOCK CYLINDER, SINGLE KEY SYSTEM	ELECTRIC STRIKE RECOMMENDED 1700 mm
UPPER ESCUTCHEON PROTECTION (THERMO PREMIUM)	AMSTERDAM / MONTREAL HANDRAIL WITH PUSHBUTTON, WITH DOOR LEAF ADJUSTMENT AND ELECTRIC STRIKE 1500 mm
KNOB-HANDLE	1000 mm
REED SWITCH	AMSTERDAM HANDRAIL WITH WIRELESS PUSHBUTTON 1700 mm
SIZE 100E	ELECTRIC STRIKE NECESSARY 1500 mm
INTEGRATED CLOSER	DOOR SHORTENING KWA, KWB, KWC (10, 20, 30, 40 mm), KWD (10, 20, 30, 40, 60, 80, 100 mm)
ELECTRIC STRIKE WITH DAY / NIGHT FEATURE	TEDEE SET

FIXED GLAZED SIDE PANELS: PAGES 88-89, FULL EQUIPMENT LIST: PAGES 94-99

GLASS

MATTE

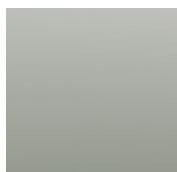

MIRA STAR MIRROR

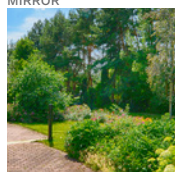

DOOR COLOURS

ALPINE WALNUT

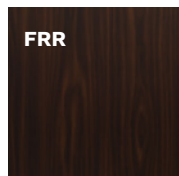

MAHOGANY

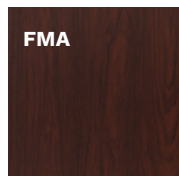

BRAZILIAN WALNUT

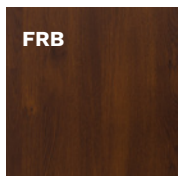

LIGHT WALNUT

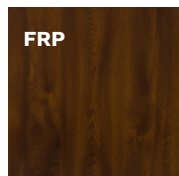

GOLDEN OAK

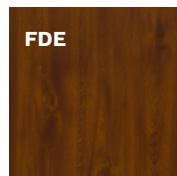

WINCHESTER

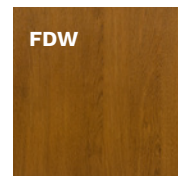

TURNER OAK





KWCB PASAWA 3 B



KWD PASAWA 4



INTERNAL SIDE

THERMO PRIME 75 DOOR CONFIGURATION



KWA PASAWA 1



INTERNAL SIDE

FITTINGS

HANDLE-HANDLE



THERMO PRIME

SOFA



THERMO PREMIUM

BERGEN



BERGEN

KNOB-HANDLE*



THERMO PRIME

BERGEN



THERMO PREMIUM

BERGEN

HANDRAIL-HANDLE*

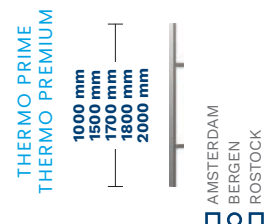

THERMO PRIME
THERMO PREMIUM

1000 mm
1500 mm
1700 mm
1800 mm
2000 mm

AMSTERDAM
BERGEN
ROSTOCK

FITTINGS' COLOURS

PLATINUM ANODE

SILVER ANODE

BLACK ANODE

DOOR COLOURS

LIGHT WENGE



FEJ

WHITE



FSB

STEEL GRAY

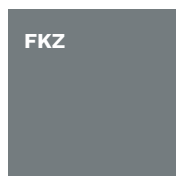

FKZ

ANTHRACITE

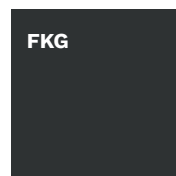

FKG

DARK ANTHRACITE

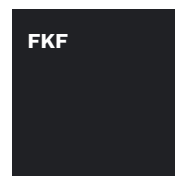

FKF

BLACK

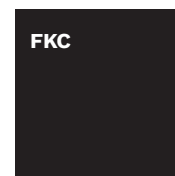

FKC

TWO-COLOUR DOOR*

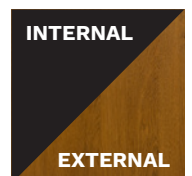

INTERNAL

EXTERNAL

* EXTRA CHARGE



KW3 JENA 3



KW4 JENA 4

Door size	80	90N	90E	100E
Door height (DUOTHERM / ALUTHERM)	2076 / 2087-2400 mm			

MODEL	THERMO PREMIUM 60	THERMO PREMIUM 75	THERMO PRIME 75
KW3 JENA 3	✓	✓	✓
KW4 JENA 4	✓	✓	✓

RC2 STANDARD EQUIPMENT

- GLAZED DOOR LEAF
- 4 SIDES REBATED
- THERMO PREMIUM – DUOTHERM DOOR FRAME
- THERMO PRIME – ALUTHERM 75 DOOR FRAME
- HINGES ADJUSTABLE IN THREE PLANES WITH CAPS MATCHING FITTING'S COLOUR
- WARM THRESHOLD
- FITTINGS SET WITH LOCK CYLINDER PROTECTION
- BERGEN ESCUTCHEONS WITH ALEX HANDLES
- THERMO PREMIUM – CLASS 5 LOCK CYLINDER, SINGLE KEY SYSTEM, BOLT LOCK
- THERMO PRIME – CLASS 5 LOCK CYLINDER, 3 POINT HOOKED MORTISE LOCK OR 5 POINT AUTOMATIC MORTISE LOCK

EXTRA CHARGES

CUSTOM HEIGHT (THERMO PRIME)	2150 – 2200 mm	
AVAILABLE COLOURS: FRP, FDE, FDW, FKG, FKF	2250 – 2300 mm	
	2350 – 2400 mm	
ALUTHERM DOOR FRAME (THERMO PREMIUM DOOR)	ROSTOCK HANDRAIL	2000 mm
TWO-COLOUR DOOR	AMSTERDAM / MONTREAL HANDRAIL ELECTRIC STRIKE RECOMMENDED	1800 mm
CLASS 6 LOCK CYLINDER, SINGLE KEY SYSTEM		1700 mm
UPPER ESCUTCHEON PROTECTION (THERMO PREMIUM)	AMSTERDAM / MONTREAL HANDRAIL WITH PUSHBUTTON, WITH DOOR LEAF ADJUSTMENT AND ELECTRIC STRIKE	1500 mm
KNOB-HANDLE	AMSTERDAM HANDRAIL WITH WIRELESS PUSHBUTTON	1700 mm
REED SWITCH	ELECTRIC STRIKE NECESSARY	1500 mm
SIZE 100E	DOOR SHORTENING (10, 20, 30, 40, 60, 80, 100 mm)	
INTEGRATED CLOSER		
ELECTRIC STRIKE WITH DAY / NIGHT FEATURE	TEDEE SET	

FIXED GLAZED SIDE PANELS: PAGES 88-89, FULL EQUIPMENT LIST: PAGES 94-99

GLASS

MATTE

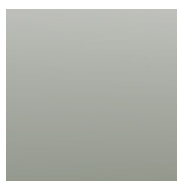

MIRA STAR
MIRROR

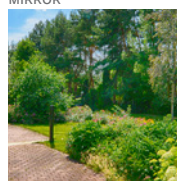

DOOR COLOURS

ALPINE WALNUT

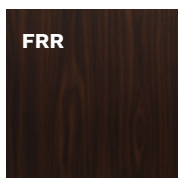

FRR

MAHOGANY

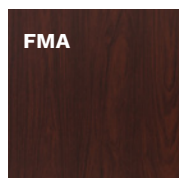

FMA

BRAZILIAN WALNUT

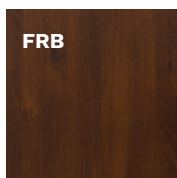

FRB

LIGHT WALNUT

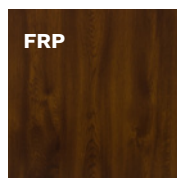

FRP

GOLDEN OAK

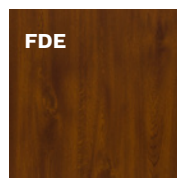

FDE

WINCHESTER

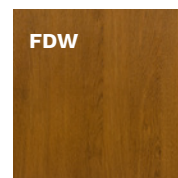

FDW

TURNER OAK



FDT



KW3B JENA 3 B



INTERNAL SIDE

THERMO PRIME 75 DOOR CONFIGURATION

FITTINGS

HANDLE-HANDLE



KNOB-HANDLE*



HANDRAIL-HANDLE*

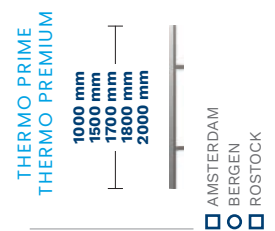

FITTINGS' COLOURS

PLATINUM ANODE

SILVER ANODE

BLACK ANODE

DOOR COLOURS

LIGHT WENGE



WHITE



STEEL GRAY

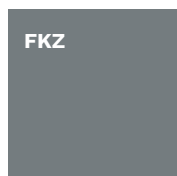

ANTHRACITE

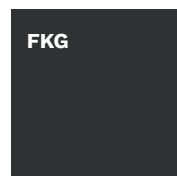

DARK ANTHRACITE

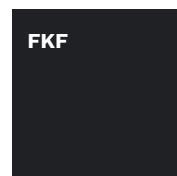

BLACK

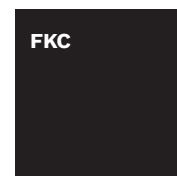

TWO-COLOUR DOOR*



* EXTRA CHARGE



KWF BAMBERG 1



KWG BAMBERG 2

Door size	80	90N	90E	100E
Door height (DUOTHERM / ALUTHERM)	2076 / 2087-2400 mm			

MODEL	THERMO PREMIUM 60	THERMO PREMIUM 75	THERMO PRIME 75
KWF BAMBERG 1 / KWFB BAMBERG 1 B	✓	✓	✓
KWG BAMBERG 2 / KWGB BAMBERG 2 B	✓	✓	✓
KWH BAMBERG 3 / KWHB BAMBERG 3 B	✓	✓	✓
KWI BAMBERG 4 / KWIB BAMBERG 4 B	✓	✓	✓

RC2 STANDARD EQUIPMENT

- GLAZED DOOR LEAF
- 4 SIDES REBATED
- THERMO PREMIUM – DUOTHERM DOOR FRAME
- THERMO PRIME – ALUTHERM 75 DOOR FRAME
- HINGES ADJUSTABLE IN THREE PLANES WITH CAPS MATCHING FITTING'S COLOUR
- INSERTS INOX BLACK
- WARM THRESHOLD
- FITTINGS SET WITH LOCK CYLINDER PROTECTION
- BERGEN ESCUTCHEONS WITH ALEX HANDLES
- THERMO PREMIUM – CLASS 5 LOCK CYLINDER, SINGLE KEY SYSTEM, BOLT LOCK
- THERMO PRIME – CLASS 5 LOCK CYLINDER, 3 POINT HOOKED MORTISE LOCK OR 5 POINT AUTOMATIC MORTISE LOCK

EXTRA CHARGES

CUSTOM HEIGHT (THERMO PRIME)	2150 - 2200 mm
AVAILABLE COLOURS: FRP, FDE, FDW, FKG, FKF	2250 - 2300 mm
	2350 - 2400 mm
ALUTHERM DOOR FRAME (THERMO PREMIUM DOOR)	ROSTOCK HANDRAIL 2000 mm
TWO-COLOUR DOOR	AMSTERDAM / MONTREAL HANDRAIL 1800 mm
CLASS 6 LOCK CYLINDER, SINGLE KEY SYSTEM	ELECTRIC STRIKE RECOMMENDED 1700 mm
UPPER ESCUTCHEON PROTECTION (THERMO PREMIUM)	AMSTERDAM / MONTREAL HANDRAIL WITH PUSHBUTTON, WITH DOOR LEAF ADJUSTMENT AND ELECTRIC STRIKE 1500 mm
KNOB-HANDLE	1000 mm
REED SWITCH	AMSTERDAM HANDRAIL WITH WIRELESS PUSHBUTTON 1700 mm
SIZE 100E	ELECTRIC STRIKE NECESSARY 1500 mm
INTEGRATED CLOSER	DOOR SHORTENING (10, 20, 30, 40 mm)
ELECTRIC STRIKE WITH DAY / NIGHT FEATURE	TEDEE SET

FIXED GLAZED SIDE PANELS: PAGES 88-89, FULL EQUIPMENT LIST: PAGES 94-99

GLASS

MATTE

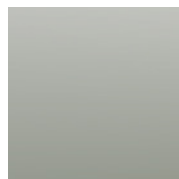

MIRA STAR MIRROR

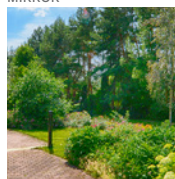

DOOR COLOURS

ALPINE WALNUT

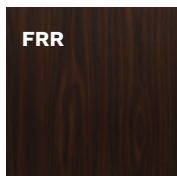

FRR

MAHOGANY

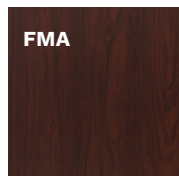

FMA

BRAZILIAN WALNUT

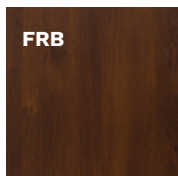

FRB

LIGHT WALNUT

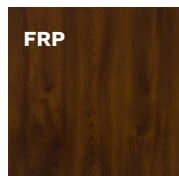

FRP

GOLDEN OAK

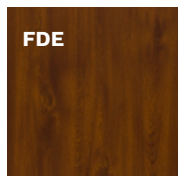

FDE

WINCHESTER

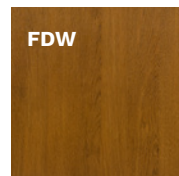

FDW

TURNER OAK



FDT



KWH BAMBERG 3



KWI BAMBERG 4



INTERNAL SIDE

THERMO PRIME 75 DOOR CONFIGURATION



KWF BAMBERG 1



INTERNAL SIDE

FITTINGS

HANDLE-HANDLE

THERMO PRIME



SOFIA

THERMO PREMIUM



BERGEN

THERMO PRIME



BERGEN

THERMO PREMIUM



BERGEN

KNOB-HANDLE*

HANDRAIL-HANDLE*

THERMO PRIME
THERMO PREMIUM

1000 mm
1500 mm
1700 mm
1800 mm
2000 mm

AMSTERDAM
BERGEN
ROSTOCK

FITTINGS' COLOURS

PLATINUM ANODE

SILVER ANODE

BLACK ANODE

DOOR COLOURS

LIGHT WENGE



WHITE



STEEL GRAY

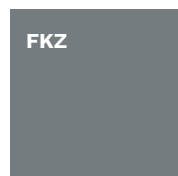

ANTHRACITE

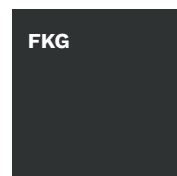

DARK ANTHRACITE

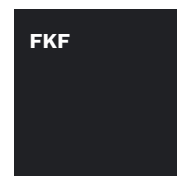

BLACK

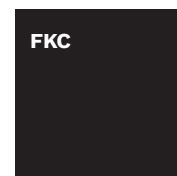

TWO-COLOUR DOOR*

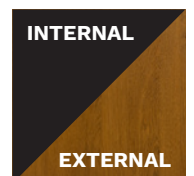

* EXTRA CHARGE



KWJB ULM 1 B



KWK ULM 2

Door size	80	90N	90E	100E
Door height (DUOTHERM / ALUTHERM)	2076 / 2087-2400 mm			

MODEL	THERMO PREMIUM 60	THERMO PREMIUM 75	THERMO PRIME 75
KWJ ULM 1 / KWJB ULM 1 B	✓	✓	-
KWK ULM 2 / KWKB ULM 2 B	✓	✓	✓

RC2 STANDARD EQUIPMENT

- GLAZED DOOR LEAF
 - 4 SIDES REBATED
 - THERMO PREMIUM – DUOTHERM DOOR FRAME
 - THERMO PRIME – ALUTHERM 75 DOOR FRAME
 - HINGES ADJUSTABLE IN THREE PLANES WITH CAPS MATCHING FITTING'S COLOUR
 - INSERTS
- INOX

BLACK
- WARM THRESHOLD
 - FITTINGS SET WITH LOCK CYLINDER PROTECTION
 - BERGEN ESCUTCHEONS WITH ALEX HANDLES
 - THERMO PREMIUM – CLASS 5 LOCK CYLINDER, SINGLE KEY SYSTEM, BOLT LOCK
 - THERMO PRIME – CLASS 5 LOCK CYLINDER, 3 POINT HOOKED MORTISE LOCK OR 5 POINT AUTOMATIC MORTISE LOCK

EXTRA CHARGES

CUSTOM HEIGHT (THERMO PRIME)	2150 – 2200 mm
AVAILABLE COLOURS: FRP, FDE, FDW, FKG, FKF	2250 – 2300 mm
	2350 – 2400 mm
ALUTHERM DOOR FRAME (THERMO PREMIUM DOOR)	ROSTOCK HANDRAIL 2000 mm
TWO-COLOUR DOOR	AMSTERDAM / MONTREAL HANDRAIL 1800 mm
	ELECTRIC STRIKE RECOMMENDED 1700 mm
CLASS 6 LOCK CYLINDER, SINGLE KEY SYSTEM	AMSTERDAM / MONTREAL HANDRAIL WITH PUSHBUTTON, WITH DOOR LEAF ADJUSTMENT AND ELECTRIC STRIKE 1500 mm
UPPER ESCUTCHEON PROTECTION (THERMO PREMIUM)	1000 mm
KNOB-HANDLE	AMSTERDAM HANDRAIL 1700 mm
REED SWITCH	WITH WIRELESS PUSHBUTTON 1500 mm
SIZE 100E	ELECTRIC STRIKE NECESSARY
INTEGRATED CLOSER	DOOR SHORTENING (10, 20, 30, 40, 60, 80, 100 mm)
ELECTRIC STRIKE WITH DAY / NIGHT FEATURE	TEDEE SET

FIXED GLAZED SIDE PANELS: PAGES 88-89, FULL EQUIPMENT LIST: PAGES 94-99

GLASS

MATTE

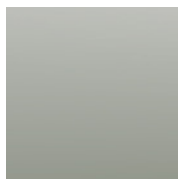

MIRA STAR MIRROR

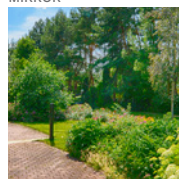

INSERT

INOX



BLACK



DOOR COLOURS

ALPINE WALNUT

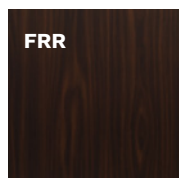

FRR

MAHOGANY

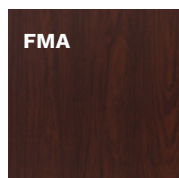

FMA

BRAZILIAN WALNUT

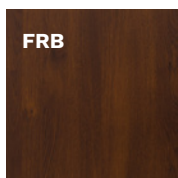

FRB

LIGHT WALNUT

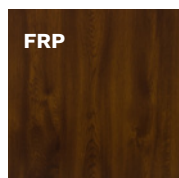

FRP

GOLDEN OAK

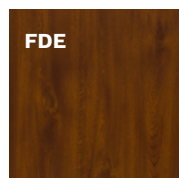

FDE

WINCHESTER

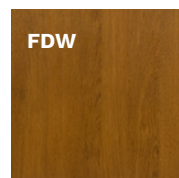

FDW

TURNER OAK



FDT



KWJ ULM 2



INTERNAL SIDE

THERMO PRIME 75 DOOR CONFIGURATION

FITTINGS

HANDLE-HANDLE



KNOB-HANDLE*



HANDRAIL-HANDLE*

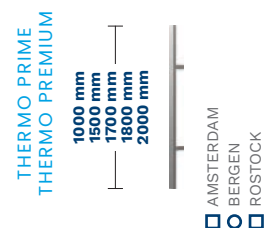

FITTINGS' COLOURS

PLATINUM ANODE

SILVER ANODE

BLACK ANODE

DOOR COLOURS

LIGHT WENGE



WHITE



STEEL GRAY

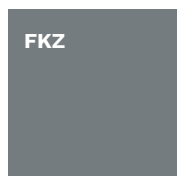

ANTHRACITE

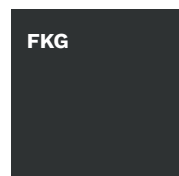

DARK ANTHRACITE

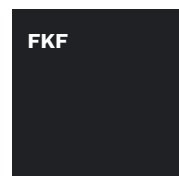

BLACK

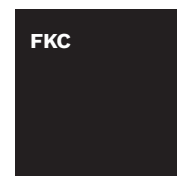

TWO-COLOUR DOOR*



* EXTRA CHARGE



KWL TREWIR 1



KWMB TREWIR 2 B

Door size	80	90N	90E	100E
Door height (DUOTHERM / ALUTHERM)	2076 / 2087-2400 mm			

MODEL	THERMO PREMIUM 60	THERMO PREMIUM 75	THERMO PRIME 75
KWL TREWIR 1 / KWL B TREWIR 1 B	✓	✓	✓
KWM TREWIR 2 / KWMB TREWIR 2 B	✓	✓	✓
KWN TREWIR 3 / KWN B TREWIR 3 B	✓	✓	✓
KWP TREWIR 4 / KWP B TREWIR 4 B	✓	✓	✓
KW7 TREWIR 7 / KW7 B TREWIR 7 B	✓	✓	✓

RC2 STANDARD EQUIPMENT

- GLAZED DOOR LEAF
- 4 SIDES REBATED
- THERMO PREMIUM – DUOTHERM DOOR FRAME
- THERMO PRIME – ALUTHERM 75 DOOR FRAME
- HINGES ADJUSTABLE IN THREE PLANES WITH CAPS MATCHING FITTING'S COLOUR
- WARM THRESHOLD
- FITTINGS SET WITH LOCK CYLINDER PROTECTION
- BERGEN ESCUTCHEONS WITH ALEX HANDLES
- THERMO PREMIUM – CLASS 5 LOCK CYLINDER, SINGLE KEY SYSTEM, BOLT LOCK
- THERMO PRIME – CLASS 5 LOCK CYLINDER, 3 POINT HOOKED MORTISE LOCK OR 5 POINT AUTOMATIC MORTISE LOCK

- INSERTS INOX BLACK

EXTRA CHARGES

CUSTOM HEIGHT (THERMO PRIME)	2150 – 2200 mm
AVAILABLE COLOURS: FRP, FDE, FDW, FKG, FKF	2250 – 2300 mm
	2350 – 2400 mm
ALUTHERM DOOR FRAME (THERMO PREMIUM DOOR)	ROSTOCK HANDRAIL 2000 mm
TWO-COLOUR DOOR	AMSTERDAM / MONTREAL HANDRAIL 1800 mm
CLASS 6 LOCK CYLINDER, SINGLE KEY SYSTEM	ELECTRIC STRIKE RECOMMENDED 1700 mm
UPPER ESCUTCHEON PROTECTION (THERMO PREMIUM)	AMSTERDAM / MONTREAL HANDRAIL WITH PUSHBUTTON, WITH DOOR LEAF ADJUSTMENT AND ELECTRIC STRIKE 1500 mm
KNOB-HANDLE	1000 mm
REED SWITCH	AMSTERDAM HANDRAIL WITH WIRELESS PUSHBUTTON 1700 mm
SIZE 100E	ELECTRIC STRIKE NECESSARY 1500 mm
INTEGRATED CLOSER	DOOR SHORTENING (10, 20, 30, 40 mm)
ELECTRIC STRIKE WITH DAY / NIGHT FEATURE	TEDEE SET

FIXED GLAZED SIDE PANELS: PAGES 88-89, FULL EQUIPMENT LIST: PAGES 94-99

GLASS

MATTE



REFLEX GRAPHITE

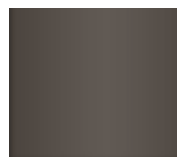

MIRA STAR MIRROR

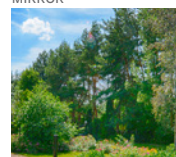

DOOR COLOURS

ALPINE WALNUT

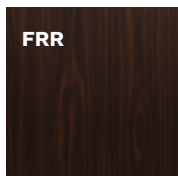

MAHOGANY

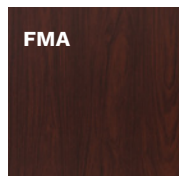

BRAZILIAN WALNUT

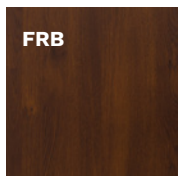

LIGHT WALNUT

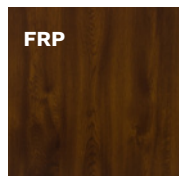

GOLDEN OAK

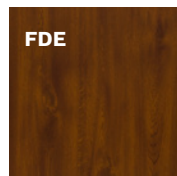

WINCHESTER

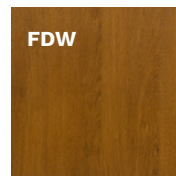

TURNER OAK





KWN TREWIR 3



KWP TREWIR 4



KW7 TREWIR 7

THERMO PRIME 75 DOOR CONFIGURATION



KWL TREWIR 1



INTERNAL SIDE

FITTINGS

HANDLE-HANDLE

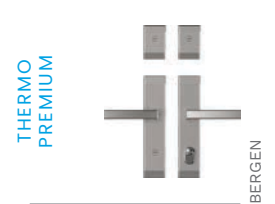

KNOB-HANDLE*



HANDRAIL-HANDLE*

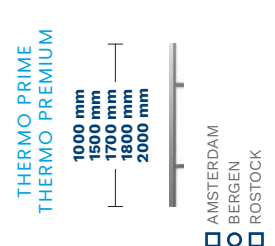

FITTINGS' COLOURS

PLATINUM ANODE

SILVER ANODE

BLACK ANODE

DOOR COLOURS

LIGHT WENGE



WHITE



STEEL GRAY

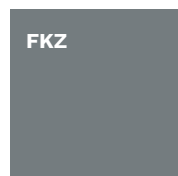

ANTHRACITE

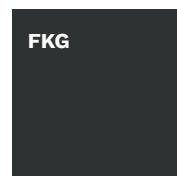

DARK ANTHRACITE

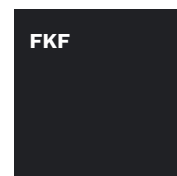

BLACK

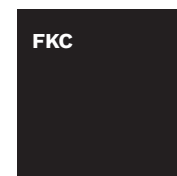

TWO-COLOUR DOOR*

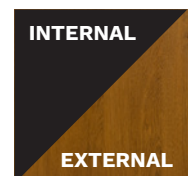

* EXTRA CHARGE



KWSB DORFEN B

Door size	80	90N	90E	100E
Door height (DUOTHERM / ALUTHERM)	2076 / 2087-2400 mm			

MODEL	THERMO PREMIUM 60	THERMO PREMIUM 75	THERMO PRIME 75
KWS DORFEN / KWSB DORFEN B	✓	✓	✓

RC2 STANDARD EQUIPMENT

• GLAZED DOOR LEAF	• WARM THRESHOLD
• 4 SIDES REBATED	• FITTINGS SET WITH LOCK CYLINDER PROTECTION
• THERMO PREMIUM – DUOTHERM DOOR FRAME	• BERGEN ESCUTCHEONS WITH ALEX HANDLES
• THERMO PRIME – ALUTHERM 75 DOOR FRAME	• THERMO PREMIUM – CLASS 5 LOCK CYLINDER, SINGLE KEY SYSTEM, BOLT LOCK
• HINGES ADJUSTABLE IN THREE PLANES WITH CAPS MATCHING FITTING'S COLOUR	• THERMO PRIME – CLASS 5 LOCK CYLINDER, 3 POINT HOOKED MORTISE LOCK OR 5 POINT AUTOMATIC MORTISE LOCK
• INSERTS	<div style="display: flex; gap: 10px;"> <div style="background-color: #cccccc; padding: 2px 10px;">INOX</div> <div style="background-color: #333333; color: white; padding: 2px 10px;">BLACK</div> </div>

EXTRA CHARGES

CUSTOM HEIGHT (THERMO PRIME)	2150 - 2200 mm
AVAILABLE COLOURS: FRP, FDE, FDW, FKG, FKF	2250 - 2300 mm
	2350 - 2400 mm
ALUTHERM DOOR FRAME (THERMO PREMIUM DOOR)	ROSTOCK HANDRAIL 2000 mm
TWO-COLOUR DOOR	AMSTERDAM / MONTREAL HANDRAIL ELECTRIC STRIKE RECOMMENDED 1800 mm
CLASS 6 LOCK CYLINDER, SINGLE KEY SYSTEM	1700 mm
UPPER ESCUTCHEON PROTECTION (THERMO PREMIUM)	AMSTERDAM / MONTREAL HANDRAIL WITH PUSHBUTTON, WITH DOOR LEAF ADJUSTMENT AND ELECTRIC STRIKE 1500 mm
KNOB-HANDLE	1000 mm
REED SWITCH	AMSTERDAM HANDRAIL WITH WIRELESS PUSHBUTTON ELECTRIC STRIKE NECESSARY 1700 mm
SIZE 100E	1500 mm
INTEGRATED CLOSER	DOOR SHORTENING (10, 20, 30, 40 mm)
ELECTRIC STRIKE WITH DAY / NIGHT FEATURE	TEDEE SET

FIXED GLAZED SIDE PANELS: PAGES 88-89, FULL EQUIPMENT LIST: PAGES 94-99

GLASS

MATTE

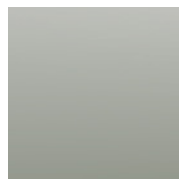

REFLEX GRAPHITE



MIRA STAR MIRROR

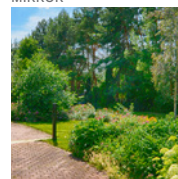

DOOR COLOURS

ALPINE WALNUT

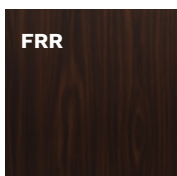

MAHOGANY

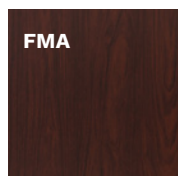

BRAZILIAN WALNUT

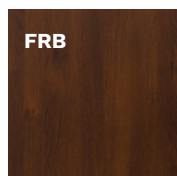

LIGHT WALNUT

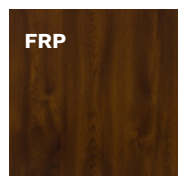

GOLDEN OAK

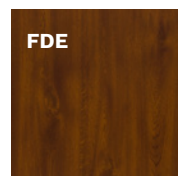

WINCHESTER

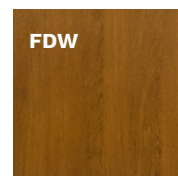

TURNER OAK





KWS DORFEN



INTERNAL SIDE

THERMO PRIME 75 DOOR CONFIGURATION

FITTINGS

HANDLE-HANDLE

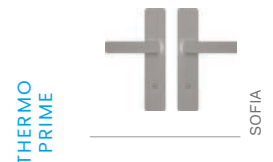

KNOB-HANDLE*



HANDRAIL-HANDLE*

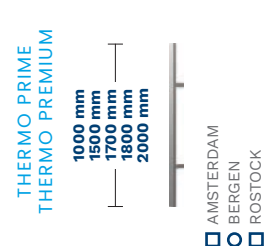

FITTINGS' COLOURS

PLATINUM ANODE

SILVER ANODE

BLACK ANODE

DOOR COLOURS

LIGHT WENGE



WHITE



STEEL GRAY

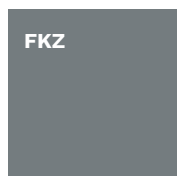

ANTHRACITE

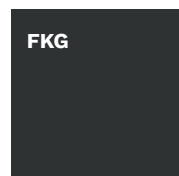

DARK ANTHRACITE

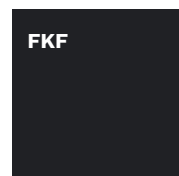

BLACK

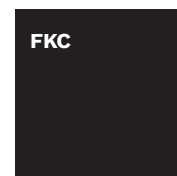

TWO-COLOUR DOOR*



* EXTRA CHARGE



KWT KASSEL 1



KWXB KASSEL 2 B

Door size	80	90N	90E	100E
Door height (DUOTHERM / ALUTHERM)	2076 / 2087-2400 mm			

MODEL	THERMO PREMIUM 60	THERMO PREMIUM 75	THERMO PRIME 75
KWT KASSEL 1 / KWTB KASSEL 1 B	✓	✓	✓
KWX KASSEL 2 / KWXB KASSEL 2 B	✓	✓	✓

RC2 STANDARD EQUIPMENT

• GLAZED DOOR LEAF	• WARM THRESHOLD
• 4 SIDES REBATED	• FITTINGS SET WITH LOCK CYLINDER PROTECTION
• THERMO PREMIUM – DUOTHERM DOOR FRAME	• BERGEN ESCUTCHEONS WITH ALEX HANDLES
• THERMO PRIME – ALUTHERM 75 DOOR FRAME	• THERMO PREMIUM – CLASS 5 LOCK CYLINDER, SINGLE KEY SYSTEM, BOLT LOCK
• HINGES ADJUSTABLE IN THREE PLANES WITH CAPS MATCHING FITTING'S COLOUR	• THERMO PRIME – CLASS 5 LOCK CYLINDER, 3 POINT HOOKED MORTISE LOCK OR 5 POINT AUTOMATIC MORTISE LOCK
• INSERTS	<div style="display: flex; gap: 10px;"> <div style="background-color: #cccccc; padding: 2px 10px; border: 1px solid black;">INOX</div> <div style="background-color: #333333; color: white; padding: 2px 10px; border: 1px solid black;">BLACK</div> </div>

EXTRA CHARGES

CUSTOM HEIGHT (THERMO PRIME)	2150 – 2200 mm
AVAILABLE COLOURS: FRP, FDE, FDW, FKG, FKF	2250 – 2300 mm
	2350 – 2400 mm
ALUTHERM DOOR FRAME (THERMO PREMIUM DOOR)	ROSTOCK HANDRAIL 2000 mm
TWO-COLOUR DOOR	AMSTERDAM / MONTREAL HANDRAIL 1800 mm
CLASS 6 LOCK CYLINDER, SINGLE KEY SYSTEM	ELECTRIC STRIKE RECOMMENDED 1700 mm
UPPER ESCUTCHEON PROTECTION (THERMO PREMIUM)	AMSTERDAM / MONTREAL HANDRAIL WITH PUSHBUTTON, WITH DOOR LEAF ADJUSTMENT AND ELECTRIC STRIKE 1500 mm
KNOB-HANDLE	1000 mm
REED SWITCH	AMSTERDAM HANDRAIL WITH WIRELESS PUSHBUTTON 1700 mm
SIZE 100E	ELECTRIC STRIKE NECESSARY 1500 mm
INTEGRATED CLOSER	DOOR SHORTENING (10, 20, 30, 40 mm)
ELECTRIC STRIKE WITH DAY / NIGHT FEATURE	TEDEE SET

FIXED GLAZED SIDE PANELS: PAGES 88–89, FULL EQUIPMENT LIST: PAGES 94–99

GLASS

MATTE

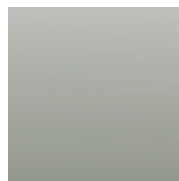

REFLEX GRAPHITE



MIRA STAR MIRROR



DOOR COLOURS

ALPINE WALNUT

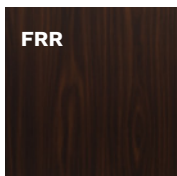

MAHOGANY

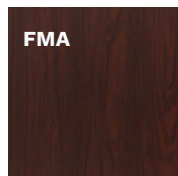

BRAZILIAN WALNUT

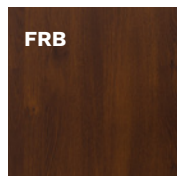

LIGHT WALNUT

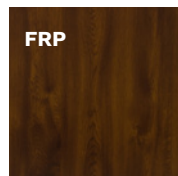

GOLDEN OAK

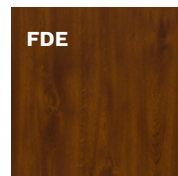

WINCHESTER

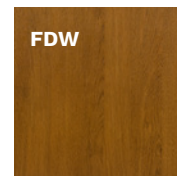

TURNER OAK





KWT KASSEL 1



INTERNAL SIDE

THERMO PRIME 75 DOOR CONFIGURATION

FITTINGS

HANDLE-HANDLE



KNOB-HANDLE*



HANDRAIL-HANDLE*

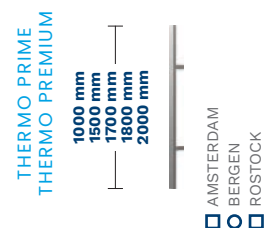

FITTINGS' COLOURS

PLATINUM ANODE

SILVER ANODE

BLACK ANODE

DOOR COLOURS

LIGHT WENGE



WHITE



STEEL GRAY

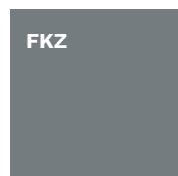

ANTHRACITE

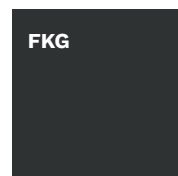

DARK ANTHRACITE

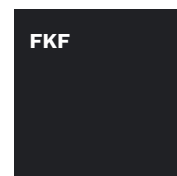

BLACK

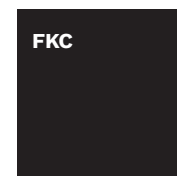

TWO-COLOUR DOOR*



* EXTRA CHARGE



KPN KRONACH 1



KPPB KRONACH 2 B

Door size	80	90N	90E	100E
Door height (DUOTHERM / ALUTHERM)	2076 / 2087-2400 mm			

MODEL	THERMO PREMIUM 60	THERMO PREMIUM 75	THERMO PRIME 75
KPN KRONACH 1 / KPNB KRONACH 1 B	✓	✓	✓
KPP KRONACH 2 / KPPB KRONACH 2 B	✓	✓	✓
KPT KRONACH 3 / KPTB KRONACH 3 B	✓	✓	-
KPZ KRONACH 4 / KPZB KRONACH 4 B	✓	✓	-

RC2 STANDARD EQUIPMENT

- SOLID DOOR LEAF
- 4 SIDES REBATED
- THERMO PREMIUM – DUOTHERM DOOR FRAME
- THERMO PRIME – ALUTHERM 75 DOOR FRAME
- HINGES ADJUSTABLE IN THREE PLANES WITH CAPS MATCHING FITTING'S COLOUR
- WARM THRESHOLD
- FITTINGS SET WITH LOCK CYLINDER PROTECTION
- BERGEN ESCUTCHEONS WITH ALEX HANDLES
- THERMO PREMIUM – CLASS 5 LOCK CYLINDER, SINGLE KEY SYSTEM, BOLT LOCK
- THERMO PRIME – CLASS 5 LOCK CYLINDER, 3 POINT HOOKED MORTISE LOCK OR 5 POINT AUTOMATIC MORTISE LOCK

• INSERTS

INOX

BLACK

EXTRA CHARGES

CUSTOM HEIGHT (THERMO PRIME)	2150 - 2200 mm
AVAILABLE COLOURS: FRP, FDE, FDW, FKG, FKF	2250 - 2300 mm
	2350 - 2400 mm
ALUTHERM DOOR FRAME (THERMO PREMIUM DOOR)	ROSTOCK HANDRAIL 2000 mm
TWO-COLOUR DOOR	AMSTERDAM / MONTREAL HANDRAIL
RC3 PACKAGE	ELECTRIC STRIKE RECOMMENDED 1800 mm
CLASS 6 LOCK CYLINDER, SINGLE KEY SYSTEM	1700 mm
UPPER ESCUTCHEON PROTECTION (THERMO PREMIUM)	AMSTERDAM / MONTREAL HANDRAIL WITH PUSHBUTTON, WITH DOOR LEAF ADJUSTMENT AND ELECTRIC STRIKE 1500 mm
KNOB-HANDLE	1000 mm
REED SWITCH	AMSTERDAM HANDRAIL WITH WIRELESS PUSHBUTTON 1700 mm
INSERT AND APPLICATION – OPPOSITE SIDE	ELECTRIC STRIKE NECESSARY 1500 mm
INSERT – OPPOSITE SIDE	DOOR SHORTENING (10, 20, 30, 40 mm)
SIZE 100E	
INTEGRATED CLOSER	TEDEE SET
ELECTRIC STRIKE WITH DAY / NIGHT FEATURE	

FIXED GLAZED SIDE PANELS: PAGES 88-89, FULL EQUIPMENT LIST: PAGES 94-99

DOOR COLOURS

ALPINE WALNUT

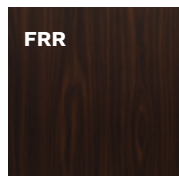

MAHOGANY

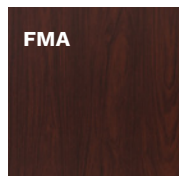

BRAZILIAN WALNUT

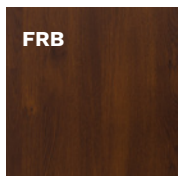

LIGHT WALNUT

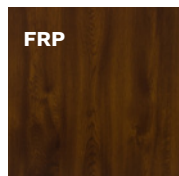

GOLDEN OAK

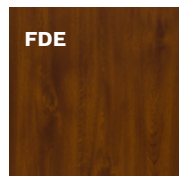

WINCHESTER

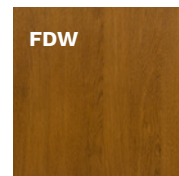

TURNER OAK





KPT KRONACH 3



KPZ KRONACH 4



INTERNAL SIDE

THERMO PRIME 75 DOOR CONFIGURATION

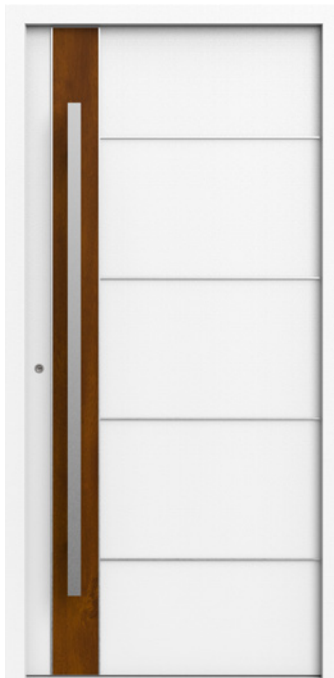

KPN KRONACH 1



INTERNAL SIDE

FITTINGS

HANDLE-HANDLE



KNOB-HANDLE*



HANDRAIL-HANDLE*

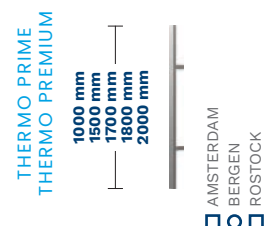

AMSTERDAM
BERGEN
ROSTOCK

FITTINGS' COLOURS

PLATINUM ANODE

SILVER ANODE

BLACK ANODE

DOOR COLOURS

LIGHT WENGE



WHITE



STEEL GRAY



ANTHRACITE

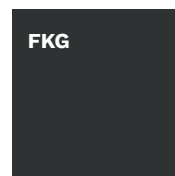

DARK ANTHRACITE

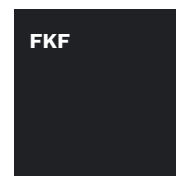

BLACK

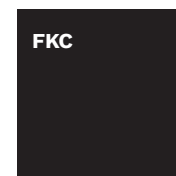

TWO-COLOUR DOOR*



* EXTRA CHARGE



KPJ REGEN 1



KPK REGEN 2

Door size	80	90N	90E	100E
Door height (DUOTHERM / ALUTHERM)	2076 / 2087-2400 mm			

MODEL	THERMO PREMIUM 60	THERMO PREMIUM 75	THERMO PRIME 75
KPJ REGEN 1 / KPJB REGEN 1 B	✓	✓	✓
KPK REGEN 2 / KPKB REGEN 2 B	✓	✓	✓
KPL REGEN 3 / KPLB REGEN 3 B	✓	✓	✓
KPS REGEN 4 / KPSB REGEN 4 B	✓	✓	✓
KPM REGEN 5 / KPMB REGEN 5 B	✓	✓	✓
KPR REGEN 6 / KPRB REGEN 6 B	✓	✓	✓

RC2 STANDARD EQUIPMENT

- SOLID DOOR LEAF
- 4 SIDES REBATED
- THERMO PREMIUM – DUOTHERM DOOR FRAME
- THERMO PRIME – ALUTHERM 75 DOOR FRAME
- HINGES ADJUSTABLE IN THREE PLANES WITH CAPS MATCHING FITTING'S COLOUR
- WARM THRESHOLD
- FITTINGS SET WITH LOCK CYLINDER PROTECTION
- BERGEN ESCUTCHEONS WITH ALEX HANDLES
- THERMO PREMIUM – CLASS 5 LOCK CYLINDER, SINGLE KEY SYSTEM, BOLT LOCK
- THERMO PRIME – CLASS 5 LOCK CYLINDER, 3 POINT HOOKED MORTISE LOCK OR 5 POINT AUTOMATIC MORTISE LOCK

- INSERTS **INOX** **BLACK**

EXTRA CHARGES

CUSTOM HEIGHT (THERMO PRIME)	2150 – 2200 mm
AVAILABLE COLOURS: FRP, FDE, FDW, FKG, FKF	2250 – 2300 mm
	2350 – 2400 mm
ALUTHERM DOOR FRAME (THERMO PREMIUM DOOR)	ROSTOCK HANDRAIL 2000 mm
TWO-COLOUR DOOR	AMSTERDAM / MONTREAL HANDRAIL
RC3 PACKAGE	ELECTRIC STRIKE RECOMMENDED 1800 mm
CLASS 6 LOCK CYLINDER, SINGLE KEY SYSTEM	AMSTERDAM / MONTREAL HANDRAIL WITH PUSHBUTTON, WITH DOOR LEAF ADJUSTMENT AND ELECTRIC STRIKE 1700 mm
UPPER ESCUTCHEON PROTECTION (THERMO PREMIUM)	1500 mm
KNOB-HANDLE	1000 mm
REED SWITCH	AMSTERDAM HANDRAIL WITH WIRELESS PUSHBUTTON 1700 mm
INSERT AND APPLICATION – OPPOSITE SIDE	ELECTRIC STRIKE NECESSARY 1500 mm
INSERT – OPPOSITE SIDE	DOOR SHORTENING (10, 20, 30, 40 mm)
SIZE 100E	
INTEGRATED CLOSER	TEDEE SET
ELECTRIC STRIKE WITH DAY / NIGHT FEATURE	

FIXED GLAZED SIDE PANELS: PAGES 88–89, FULL EQUIPMENT LIST: PAGES 94–99

DOOR COLOURS

ALPINE WALNUT

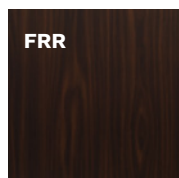

FRR

MAHOGANY

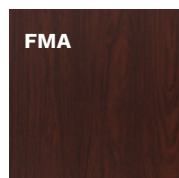

FMA

BRAZILIAN WALNUT

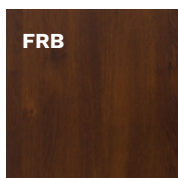

FRB

LIGHT WALNUT

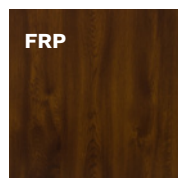

FRP

GOLDEN OAK

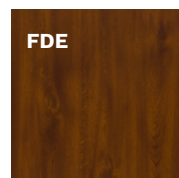

FDE

WINCHESTER

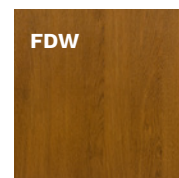

FDW

TURNER OAK



FDT



KPL REGEN 3



KPS REGEN 4



KPM REGEN 5

THERMO PRIME 75 DOOR CONFIGURATION



KPRB REGEN 6 B



KPJ REGEN 1



INTERNAL SIDE

FITTINGS

HANDLE-HANDLE



KNOB-HANDLE*



HANDRAIL-HANDLE*

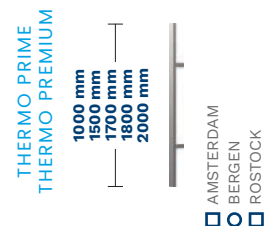

FITTINGS' COLOURS

PLATINUM ANODE

SILVER ANODE

BLACK ANODE

DOOR COLOURS

LIGHT WENGE



WHITE



STEEL GRAY

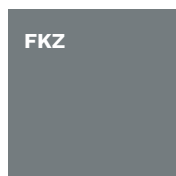

ANTHRACITE

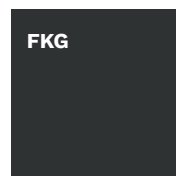

DARK ANTHRACITE

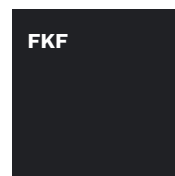

BLACK

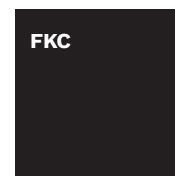

TWO-COLOUR DOOR*



* EXTRA CHARGE



KPE DREZNO 1



KPFB DREZNO 2 B

Door size	80	90N	90E	100E
Door height (DUOTHERM / ALUTHERM)	2076 / 2087-2400 mm			

MODEL	THERMO PREMIUM 60	THERMO PREMIUM 75	THERMO PRIME 75
KPE DREZNO 1 / KPEB DREZNO 1 B	✓	✓	-
KPF DREZNO 2 / KPFB DREZNO 2 B	✓	✓	-
KPH DREZNO 4 / KPHB DREZNO 4 B	✓	✓	✓

RC2 STANDARD EQUIPMENT

- SOLID DOOR LEAF
- 4 SIDES REBATED
- THERMO PREMIUM – DUOTHERM DOOR FRAME
- THERMO PRIME – ALUTHERM 75 DOOR FRAME
- HINGES ADJUSTABLE IN THREE PLANES WITH CAPS MATCHING FITTING'S COLOUR
- INSERTS INOX BLACK
- WARM THRESHOLD
- FITTINGS SET WITH LOCK CYLINDER PROTECTION
- BERGEN ESCUTCHEONS WITH ALEX HANDLES
- THERMO PREMIUM – CLASS 5 LOCK CYLINDER, SINGLE KEY SYSTEM, BOLT LOCK
- THERMO PRIME – CLASS 5 LOCK CYLINDER, 3 POINT HOOKED MORTISE LOCK OR 5 POINT AUTOMATIC MORTISE LOCK

EXTRA CHARGES

CUSTOM HEIGHT (THERMO PRIME)	2150 – 2200 mm
AVAILABLE COLOURS: FRP, FDE, FDW, FKG, FKF	2250 – 2300 mm
	2350 – 2400 mm
ALUTHERM DOOR FRAME (THERMO PREMIUM DOOR)	ROSTOCK HANDRAIL 2000 mm
TWO-COLOUR DOOR	AMSTERDAM / MONTREAL HANDRAIL
RC3 PACKAGE	ELECTRIC STRIKE RECOMMENDED 1800 mm
CLASS 6 LOCK CYLINDER, SINGLE KEY SYSTEM	1700 mm
UPPER ESCUTCHEON PROTECTION (THERMO PREMIUM)	AMSTERDAM / MONTREAL HANDRAIL WITH PUSHBUTTON, WITH DOOR LEAF ADJUSTMENT AND ELECTRIC STRIKE 1500 mm
KNOB-HANDLE	1000 mm
REED SWITCH	AMSTERDAM HANDRAIL WITH WIRELESS PUSHBUTTON 1700 mm
INSERT – OPPOSITE SIDE	ELECTRIC STRIKE NECESSARY 1500 mm
SIZE 100E	DOOR SHORTENING (10, 20, 30, 40 mm)
INTEGRATED CLOSER	
ELECTRIC STRIKE WITH DAY / NIGHT FEATURE	TEDEE SET

FIXED GLAZED SIDE PANELS: PAGES 88–89, FULL EQUIPMENT LIST: PAGES 94–99

DOOR COLOURS

ALPINE WALNUT

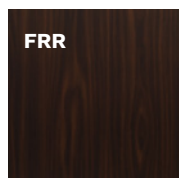

MAHOGANY

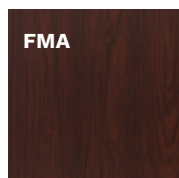

BRAZILIAN WALNUT

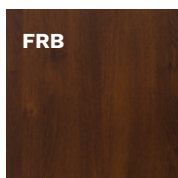

LIGHT WALNUT

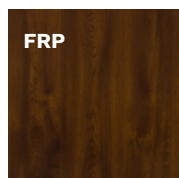

GOLDEN OAK

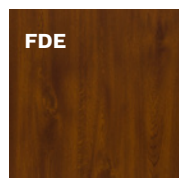

WINCHESTER

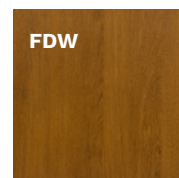

TURNER OAK





KPH DREZNO 4



INTERNAL SIDE

THERMO PRIME 75 DOOR CONFIGURATION



KPE DREZNO 4



INTERNAL SIDE

FITTINGS

HANDLE-HANDLE



KNOB-HANDLE*



HANDRAIL-HANDLE*

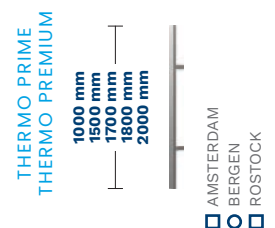

FITTINGS' COLOURS

PLATINUM ANODE

SILVER ANODE

BLACK ANODE

DOOR COLOURS

LIGHT WENGE



WHITE



STEEL GRAY

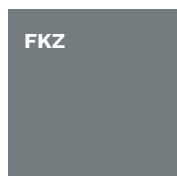

ANTHRACITE

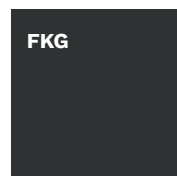

DARK ANTHRACITE

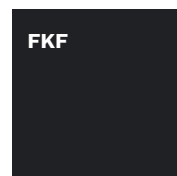

BLACK

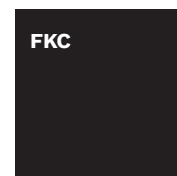

TWO-COLOUR DOOR*



* EXTRA CHARGE



KPAB ERFURT 1 B



KPB ERFURT 2

Szerokość drzwi	80	90N	90E	100E
Wysokość drzwi (DUOTHERM / ALUTHERM)	2076 / 2087-2400 mm			

MODEL	THERMO PREMIUM 60	THERMO PREMIUM 75	THERMO PRIME 75
KPA ERFURT 1 / KPAB ERFURT 1 B	✓	✓	✓
KPB ERFURT 2 / KPBB ERFURT 2 B	✓	✓	✓
KPC ERFURT 3 / KPCB ERFURT 3 B	✓	✓	✓

RC2 STANDARD EQUIPMENT

- SOLID DOOR LEAF
- 4 SIDES REBATED
- THERMO PREMIUM – DUOTHERM DOOR FRAME
- THERMO PRIME – ALUTHERM 75 DOOR FRAME
- HINGES ADJUSTABLE IN THREE PLANES WITH CAPS MATCHING FITTING'S COLOUR
- INSERTS

INOX	BLACK
------	-------
- WARM THRESHOLD
- FITTINGS SET WITH LOCK CYLINDER PROTECTION
- BERGEN ESCUTCHEONS WITH ALEX HANDLES
- THERMO PREMIUM – CLASS 5 LOCK CYLINDER, SINGLE KEY SYSTEM, BOLT LOCK
- THERMO PRIME – CLASS 5 LOCK CYLINDER, 3 POINT HOOKED MORTISE LOCK OR 5 POINT AUTOMATIC MORTISE LOCK

EXTRA CHARGES

CUSTOM HEIGHT (THERMO PRIME)	2150 – 2200 mm	
AVAILABLE COLOURS: FRP, FDE, FDW, FKG, FKF	2250 – 2300 mm	
	2350 – 2400 mm	
ALUTHERM DOOR FRAME (THERMO PREMIUM DOOR)	ROSTOCK HANDRAIL	2000 mm
TWO-COLOUR DOOR	AMSTERDAM / MONTREAL HANDRAIL	
RC3 PACKAGE	ELECTRIC STRIKE RECOMMENDED	1800 mm
CLASS 6 LOCK CYLINDER, SINGLE KEY SYSTEM		1700 mm
UPPER ESCUTCHEON PROTECTION (THERMO PREMIUM)	AMSTERDAM / MONTREAL HANDRAIL WITH PUSHBUTTON, WITH DOOR LEAF ADJUSTMENT AND ELECTRIC STRIKE	1500 mm
KNOB-HANDLE		1000 mm
REED SWITCH	AMSTERDAM HANDRAIL WITH WIRELESS PUSHBUTTON	1700 mm
INSERT – OPPOSITE SIDE	ELECTRIC STRIKE NECESSARY	1500 mm
SIZE 100E	DOOR SHORTENING (10, 20, 30, 40 mm)	
INTEGRATED CLOSER		
ELECTRIC STRIKE WITH DAY / NIGHT FEATURE	TEDEE SET	

FIXED GLAZED SIDE PANELS: PAGES 88–89, FULL EQUIPMENT LIST: PAGES 94–99

DOOR COLOURS

ALPINE WALNUT

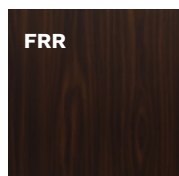

FRR

MAHOGANY

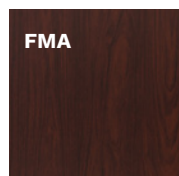

FMA

BRAZILIAN WALNUT

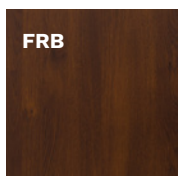

FRB

LIGHT WALNUT

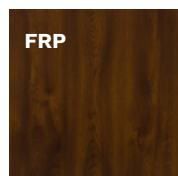

FRP

GOLDEN OAK

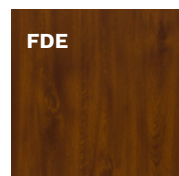

FDE

WINCHESTER

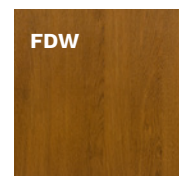

FDW

TURNER OAK



FDT



KPC ERFURT 3



INTERNAL SIDE

THERMO PRIME 75 DOOR CONFIGURATION



KPA ERFURT 1



INTERNAL SIDE

FITTINGS

HANDLE-HANDLE



KNOB-HANDLE*



HANDRAIL-HANDLE*

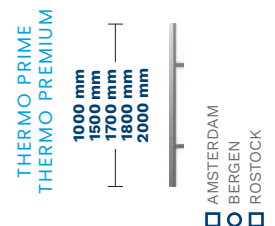

FITTINGS' COLOURS

PLATINUM ANODE

SILVER ANODE

BLACK ANODE

DOOR COLOURS

LIGHT WENGE



WHITE



STEEL GRAY

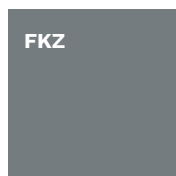

ANTHRACITE

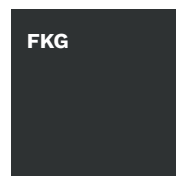

DARK ANTHRACITE

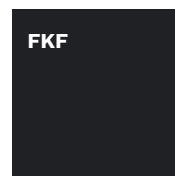

BLACK

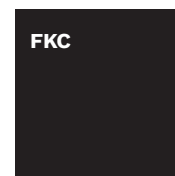

TWO-COLOUR DOOR*



* EXTRA CHARGE

ELITE 3D

BRIG / OLTEN / VISP / TRIN / BERNO



ELA BRIG

Door size	80	90N	90E	100E
Door height (DUOTHERM / ALUTHERM)	2076 / 2087-2400 mm			

MODEL	THERMO PREMIUM 60	THERMO PREMIUM 75	THERMO PRIME 75
ELA BRIG	✓	✓	✓
ELB OLTEN	✓	✓	✓
ELC VISP	✓	✓	✓
ELD TRIN	✓	✓	✓
ELE BERNO	✓	✓	-

RC2 STANDARD EQUIPMENT

• SOLID DOOR LEAF	• WARM THRESHOLD
• 4 SIDES REBATED	• FITTINGS SET WITH LOCK CYLINDER PROTECTION
• THERMO PREMIUM – DUOTHERM DOOR FRAME	• BERGEN ESCUTCHEONS WITH ALEX HANDLES
• THERMO PRIME – ALUTHERM 75 DOOR FRAME	• THERMO PREMIUM – CLASS 5 LOCK CYLINDER, SINGLE KEY SYSTEM, BOLT LOCK
• HINGES ADJUSTABLE IN THREE PLANES WITH CAPS MATCHING FITTING'S COLOUR	• THERMO PRIME – CLASS 5 LOCK CYLINDER, 3 POINT HOOKED MORTISE LOCK OR 5 POINT AUTOMATIC MORTISE LOCK

EXTRA CHARGES

CUSTOM HEIGHT (THERMO PRIME)	2150 – 2200 mm
AVAILABLE COLOURS: FRP, FDE, FDW, FKG, FKF	2250 – 2300 mm
	2350 – 2400 mm
ALUTHERM DOOR FRAME (THERMO PREMIUM DOOR)	REED SWITCH
TWO-COLOUR DOOR	FRAME – OPPOSITE SIDE
RC3 PACKAGE	SIZE 100E
CLASS 6 LOCK CYLINDER, SINGLE KEY SYSTEM	INTEGRATED CLOSER
UPPER ESCUTCHEON PROTECTION (THERMO PREMIUM)	ELECTRIC STRIKE WITH DAY / NIGHT FEATURE
KNOB-HANDLE	DOOR SHORTENING (10, 20, 30, 40 mm)
	TEDEE SET

FIXED GLAZED SIDE PANELS: PAGES 88-89, FULL EQUIPMENT LIST: PAGES 94-99



ELB OLTEN

FRAME

CLASSIC



MODERN



DOOR COLOURS

ALPINE WALNUT

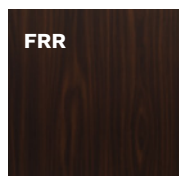

MAHOGANY

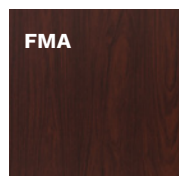

BRAZILIAN WALNUT

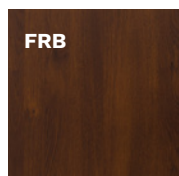

LIGHT WALNUT

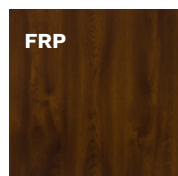

GOLDEN OAK

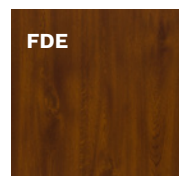

WINCHESTER

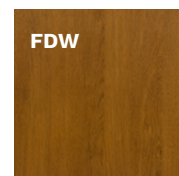

TURNER OAK





ELC VISP



ELD TRIN



ELE BERNO

THERMO PRIME 75 DOOR CONFIGURATION



ELA BRIG



INTERNAL SIDE

FITTINGS

HANDLE-HANDLE

THERMO
PRIME



SOFIA

THERMO
PREMIUM



BERGEN

THERMO
PRIME



BERGEN

THERMO
PREMIUM



BERGEN

FITTINGS' COLOURS

PLATINUM ANODE

SILVER ANODE

BLACK ANODE

DOOR COLOURS

LIGHT WENGE



FEJ

WHITE



FSB

STEEL GRAY

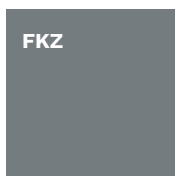

FKZ

ANTHRACITE

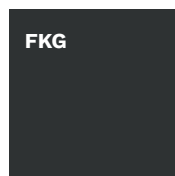

FKG

DARK ANTHRACITE

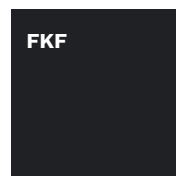

FKF

BLACK

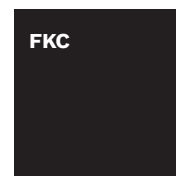

FKC

TWO-COLOUR DOOR*



INTERNAL

EXTERNAL

* EXTRA CHARGE



NS1B MILANO 8 B



NS2 MILANO 9

Door size (THERMO PRIME, THERMO PREMIUM)	-	80	90N	90E	100E
Door height (DUOTHERM, PERFOTHERM / ALUTHERM)	2076 / 2087-2400 mm				
Door size (OPTIMA)	80N	80	90N	90E	100E

MODEL	OPTIMA 60	THERMO PREMIUM 60	THERMO PREMIUM 75	THERMO PRIME 75
NS1 MILANO 8 / NS1B MILANO 8 B	✓	✓	✓	✓
NS2 MILANO 9 / NS2B MILANO 9 B	✓	✓	✓	✓
NS3 MILANO 10 / NS3B MILANO 10 B	✓	✓	✓	✓
NS4 MILANO 11 / NS4B MILANO 11 B	✓	✓	✓	✓
NS9 MILANO 12 / NS9B MILANO 12 B	✓	✓	✓	✓

RC2 STANDARD EQUIPMENT

- GLAZED DOOR LEAF
- THERMO PRIME, THERMO PREMIUM – 4 SIDES REBATED
- OPTIMA – 3 SIDES REBATED
- THERMO PRIME – ALUTHERM DOOR FRAME
- THERMO PREMIUM – DUOTHERM DOOR FRAME
- OPTIMA – PERFOTHERM DOOR FRAME
- THERMO PRIME, THERMO PREMIUM – HINGES ADJUSTABLE IN THREE PLANES WITH CAPS MATCHING FITTING'S COLOUR
- OPTIMA – HINGES ADJUSTABLE IN TWO PLANES WITH CAPS MATCHING FITTING'S COLOUR
- DOUBLE-SIDED PATTERN
- ALUMINUM THRESHOLD
- FITTINGS SET WITH LOCK CYLINDER PROTECTION
- THERMO PRIME – BERGEN SPLIT ESCUTCHEONS
- THERMO PREMIUM – BERGEN LONG ESCUTCHEONS
- OPTIMA – BLOK SPLIT ESCUTCHEONS
- THERMO PRIME – CLASS 5 LOCK CYLINDER, 3 POINT HOOKED MORTISE LOCK OR 5 POINT AUTOMATIC MORTISE LOCK
- THERMO PREMIUM, OPTIMA – CLASS 5 LOCK CYLINDER, SINGLE KEY SYSTEM, BOLT LOCK

EXTRA CHARGES

CUSTOM HEIGHT (THERMO PRIME)	2150 - 2200 mm	
AVAILABLE COLOURS: FRP, FDE, FDW, FKG, FKF	2250 - 2300 mm	
	2350 - 2400 mm	
ALUTHERM 75 DOOR FRAME	ROSTOCK HANDRAIL (T. PRIME, T.PREMIUM)	2000 mm
ALUTHERM 60 DOOR FRAME	AMSTERDAM / MONTREAL HANDRAIL	
TWO-COLOUR DOOR	ELECTRIC STRIKE RECOMMENDED	1800 mm
CLASS 6 LOCK CYLINDER, SINGLE KEY SYSTEM		1700 mm
UPPER ESCUTCHEON PROTECTION (THERMO PREMIUM, OPTIMA)	AMSTERDAM / MONTREAL HANDRAIL WITH PUSHBUTTON, WITH DOOR LEAF ADJUSTMENT AND ELECTRIC STRIKE	1500 mm
KNOB-HANDLE		1000 mm
REED SWITCH	AMSTERDAM HANDRAIL WITH WIRELESS PUSHBUTTON	1700 mm
SIZE 100E	ELECTRIC STRIKE NECESSARY	1500 mm
INTEGRATED CLOSER (THERMO PRIME, THERMO PREMIUM)	DOOR SHORTENING NS1, NS2, NS3, NS9 (10, 20, 30, 40 mm)	
	NS4 (10, 20, 30, 40, 60, 80, 100 mm)	
ELECTRIC STRIKE WITH DAY / NIGHT FEATURE	TEDEE SET	

FIXED GLAZED SIDE PANELS: PAGES 88-89, FULL EQUIPMENT LIST: PAGES 94-99

GLASS

MATTE



MATTE SEE-THROUGH STRIPES



MIRA STAR MIRROR



DOOR COLOURS

ALPINE WALNUT

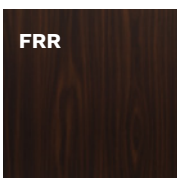

FRR

MAHOGANY

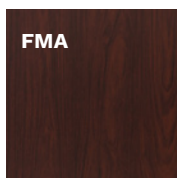

FMA

BRAZILIAN WALNUT

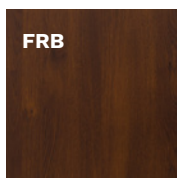

FRB

LIGHT WALNUT

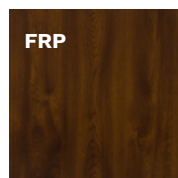

FRP

GOLDEN OAK

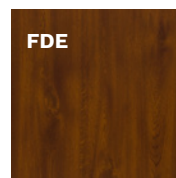

FDE

WINCHESTER

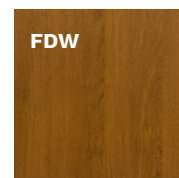

FDW

TURNER OAK



FDT



NS3 MILANO 10



NS4 MILANO 11



NS9 MILANO 12

THERMO PRIME 75 DOOR CONFIGURATION



NS1B MILANO 8 B



INTERNAL SIDE

FITTINGS

HANDLE-HANDLE

THERMO PRIME



SOFIA

THERMO PREMIUM OPTIMA 60



BERGEN



BERGEN

OPTIMA 60



BLOK



BERGEN

HANDRAIL-HANDLE*

THERMO PRIME
THERMO PREMIUM
OPTIMA 60

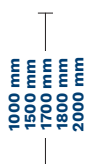

AMSTERDAM
BERGEN
ROSTOCK

FITTINGS' COLOURS

PLATINUM ANODE

SILVER ANODE

BLACK ANODE

DOOR COLOURS

LIGHT WENGE



FEJ

WHITE



FSB

STEEL GRAY

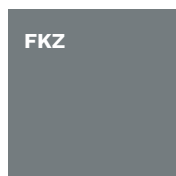

FKZ

ANTHRACITE

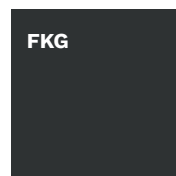

FKG

DARK ANTHRACITE

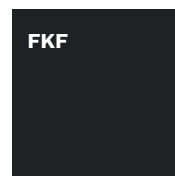

FKF

BLACK

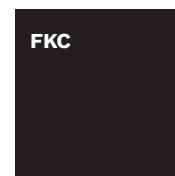

FKC

TWO-COLOUR DOOR*



INTERNAL

EXTERNAL

* EXTRA CHARGE

TEMPO HANOVER / INNSBRUCK

GERDA®



NS5B HANOVER 5 B

Door size (THERMO PRIME, THERMO PREMIUM)	-	80	90N	90E	100E
Door height (DUOTHERM, PERFOTHERM / ALUTHERM)	2076 / 2087-2400 mm				
Door size (OPTIMA)	80N	80	90N	90E	100E

MODEL	OPTIMA 60	THERMO PREMIUM 60	THERMO PREMIUM 75	THERMO PRIME 75
NS5 HANOVER 5 / NS5B HANOVER 5 B	✓	✓	✓	✓
NS6 HANOVER 6 / NS6B HANOVER 6 B	✓	✓	✓	✓
NS7 INNSBRUCK / NS7B INNSBRUCK B	✓	✓	✓	✓

RC2 STANDARD EQUIPMENT

<ul style="list-style-type: none"> GLAZED DOOR LEAF THERMO PRIME, THERMO PREMIUM – 4 SIDES REBATED OPTIMA – 3 SIDES REBATED THERMO PRIME – ALUTHERM DOOR FRAME THERMO PREMIUM – DUOTHERM DOOR FRAME OPTIMA – PERFOTHERM DOOR FRAME 	<ul style="list-style-type: none"> ALUMINUM THRESHOLD FITTINGS SET WITH LOCK CYLINDER PROTECTION THERMO PRIME – BERGEN SPLIT ESCUTCHEONS THERMO PREMIUM – BERGEN LONG ESCUTCHEONS OPTIMA – BLOK SPLIT ESCUTCHEONS
<ul style="list-style-type: none"> THERMO PRIME, THERMO PREMIUM – HINGES ADJUSTABLE IN THREE PLANES WITH CAPS MATCHING FITTING'S COLOUR OPTIMA – HINGES ADJUSTABLE IN TWO PLANES WITH CAPS MATCHING FITTING'S COLOUR DOUBLE-SIDED PATTERN 	<ul style="list-style-type: none"> THERMO PRIME – CLASS 5 LOCK CYLINDER, 3 POINT HOOKED MORTISE LOCK OR 5 POINT AUTOMATIC MORTISE LOCK THERMO PREMIUM, OPTIMA – CLASS 5 LOCK CYLINDER, SINGLE KEY SYSTEM, BOLT LOCK

EXTRA CHARGES

CUSTOM HEIGHT (THERMO PRIME) AVAILABLE COLOURS: FRP, FDE, FDW, FKG, FKF	2150 – 2200 mm 2250 – 2300 mm 2350 – 2400 mm
ALUTHERM 75 DOOR FRAME ALUTHERM 60 DOOR FRAME	ROSTOCK HANDRAIL (T. PRIME, T.PREMIUM) 2000 mm
TWO-COLOUR DOOR	AMSTERDAM / MONTREAL HANDRAIL ELECTRIC STRIKE RECOMMENDED 1800 mm
CLASS 6 LOCK CYLINDER, SINGLE KEY SYSTEM	1700 mm
UPPER ESCUTCHEON PROTECTION (THERMO PREMIUM, OPTIMA)	AMSTERDAM / MONTREAL HANDRAIL WITH PUSHBUTTON, WITH DOOR LEAF ADJUSTMENT AND ELECTRIC STRIKE 1500 mm 1000 mm
KNOB-HANDLE	
REED SWITCH	AMSTERDAM HANDRAIL WITH WIRELESS PUSHBUTTON 1700 mm
SIZE 100E	ELECTRIC STRIKE NECESSARY 1500 mm
INTEGRATED CLOSER (THERMO PRIME, THERMO PREMIUM)	DOOR SHORTENING NS1, NS2, NS3, NS9 (10, 20, 30, 40 mm) NS4 (10, 20, 30, 40, 60, 80, 100 mm)
ELECTRIC STRIKE WITH DAY / NIGHT FEATURE	TEDEE SET

FIXED GLAZED SIDE PANELS: PAGES 88-89, FULL EQUIPMENT LIST: PAGES 94-99



NS6 HANOVER 6

GLASS

MATTE



MIRA STAR
MIRROR



DOOR COLOURS

ALPINE WALNUT

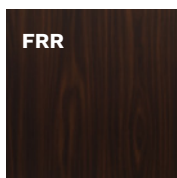

MAHOGANY

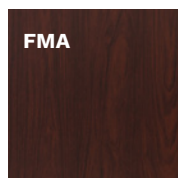

BRAZILIAN WALNUT

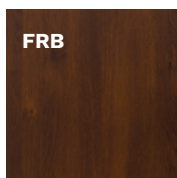

LIGHT WALNUT

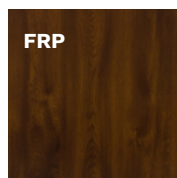

GOLDEN OAK

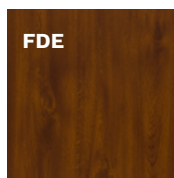

WINCHESTER

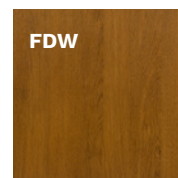

TURNER OAK



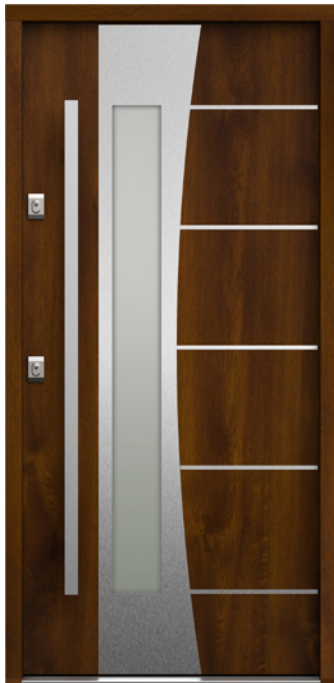

NS7 INNSBRUCK

THERMO PRIME 75 DOOR CONFIGURATION



NS5B HANOVER 5 B



INTERNAL SIDE

FITTINGS

HANDLE-HANDLE

THERMO PRIME



SOFIA



BERGEN

THERMO PREMIUM OPTIMA 60



BERGEN

OPTIMA 60



BLOK



BERGEN

HANDRAIL-HANDLE*

THERMO PRIME
THERMO PREMIUM
OPTIMA 60

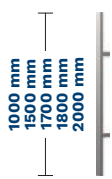

AMSTERDAM
BERGEN
ROSTOCK

FITTINGS' COLOURS

PLATINUM ANODE

SILVER ANODE

BLACK ANODE

DOOR COLOURS

LIGHT WENGE



WHITE



STEEL GRAY

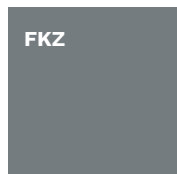

ANTHRACITE

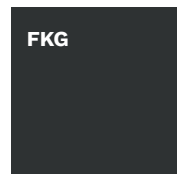

DARK ANTHRACITE

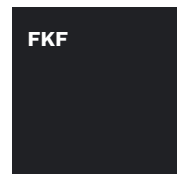

BLACK

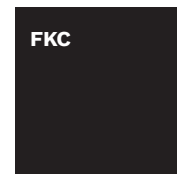

TWO-COLOUR DOOR*



* EXTRA CHARGE



W00 PLAIN

Door size (THERMO PRIME, THERMO PREMIUM)	-	80	90N	90E	100E
Door height (DUOTHERM, PERFOTHERM / ALUTHERM)	2076 / 2087-2400 mm				
Door size (OPTIMA)	80N	80	90N	90E	100E

MODEL	OPTIMA 50	OPTIMA 60	THERMO PREMIUM 60	THERMO PREMIUM 75	THERMO PRIME 75
W00 PLAIN	✓	✓	✓	✓	✓

RC2 STANDARD EQUIPMENT

• SOLID DOOR LEAF	• ALUMINUM THRESHOLD
• THERMO PRIME, THERMO PREMIUM – 4 SIDES REBATED	• FITTINGS SET WITH LOCK CYLINDER PROTECTION
• OPTIMA – 3 SIDES REBATED	
• THERMO PRIME – ALUTHERM DOOR FRAME	• THERMO PRIME – BERGEN SPLIT ESCUTCHEONS
• THERMO PREMIUM – DUOTHERM DOOR FRAME	• THERMO PREMIUM – BERGEN LONG ESCUTCHEONS
• OPTIMA – PERFOTHERM DOOR FRAME	• OPTIMA – BLOK SPLIT ESCUTCHEONS
• THERMO PRIME, THERMO PREMIUM – HINGES ADJUSTABLE IN THREE PLANES WITH CAPS MATCHING FITTING'S COLOUR	• THERMO PRIME – CLASS 5 LOCK CYLINDER, 3 POINT HOOKED MORTISE LOCK OR 5 POINT AUTOMATIC MORTISE LOCK
• OPTIMA – HINGES ADJUSTABLE IN TWO PLANES WITH CAPS MATCHING FITTING'S COLOUR	• THERMO PREMIUM, OPTIMA – CLASS 5 LOCK CYLINDER, SINGLE KEY SYSTEM, BOLT LOCK

EXTRA CHARGES

CUSTOM HEIGHT (THERMO PRIME)	2150 – 2200 mm	
AVAILABLE COLOURS: FRP, FDE, FDW, FKG, FKF	2250 – 2300 mm	
	2350 – 2400 mm	
ALUTHERM 75 DOOR FRAME	ELECTRIC STRIKE WITH DAY / NIGHT FEATURE	
ALUTHERM 60 DOOR FRAME		
PERFOTHERM 50 DOOR FRAME	ROSTOCK HANDRAIL (THERMO PRIME, THERMO PREMIUM)	2000 mm
TWO-COLOUR DOOR	AMSTERDAM / MONTREAL HANDRAIL	
RC3 PACKAGE	ELECTRIC STRIKE RECOMMENDED	1800 mm
CLASS 6 LOCK CYLINDER, SINGLE KEY SYSTEM		1700 mm
UPPER ESCUTCHEON PROTECTION (THERMO PREMIUM, OPTIMA)	AMSTERDAM / MONTREAL HANDRAIL WITH PUSHBUTTON, WITH DOOR LEAF ADJUSTMENT AND ELECTRIC STRIKE	1500 mm
		1000 mm
KNOB-HANDLE	AMSTERDAM HANDRAIL WITH WIRELESS PUSHBUTTON	1700 mm
REED SWITCH	ELECTRIC STRIKE NECESSARY	1500 mm
SIZE 100E	DOOR SHORTENING (10, 20, 30, 40, 60, 80, 100 mm)	
INTEGRATED CLOSER (THERMO PRIME, THERMO PREMIUM)	TEDEE SET	

FIXED GLAZED SIDE PANELS: PAGES 88–89, FULL EQUIPMENT LIST: PAGES 94–99

DOOR COLOURS

ALPINE WALNUT

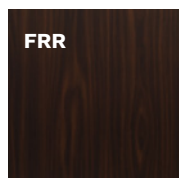

MAHOGANY

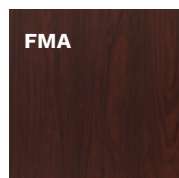

BRAZILIAN WALNUT

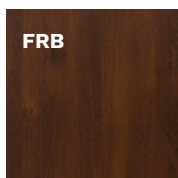

LIGHT WALNUT

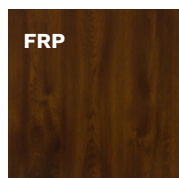

GOLDEN OAK

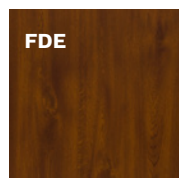

WINCHESTER

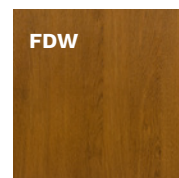

TURNER OAK





WOO PLAIN



INTERNAL SIDE

THERMO PRIME 75 DOOR CONFIGURATION



WOO PLAIN



INTERNAL SIDE

FITTINGS

HANDLE-HANDLE

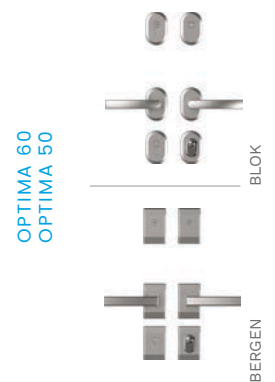
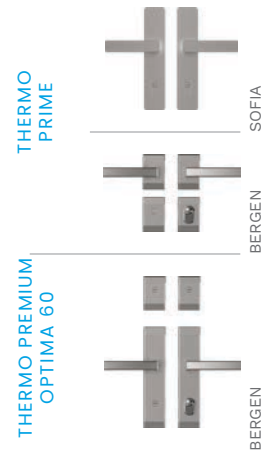

HANDRAIL-HANDLE*

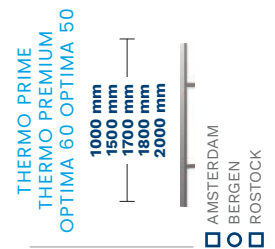

FITTINGS' COLOURS

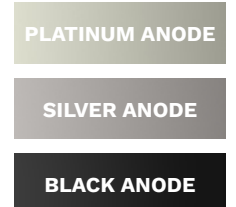

DOOR COLOURS



* EXTRA CHARGE



SNU MILANO 4



SNUA MILANO 4 A

Door size	80N	80	90N	90E	100E
Door height (PERFOTHERM / ALUTHERM)	2076 / 2087 mm				

MODEL	OPTIMA 50	OPTIMA 60
SNU MILANO 4	-	✓
SNUA MILANO 4 A	-	✓
SNUB MILANO 4 B	-	✓

RC2 STANDARD EQUIPMENT

- GLAZED DOOR LEAF
- 3 SIDES REBATED
- PERFOTHERM DOOR FRAME
- HINGES ADJUSTABLE IN TWO PLANES WITH CAPS MATCHING FITTING'S COLOUR
- DOUBLE-SIDED PATTERN
- ALUMINUM THRESHOLD
- FITTINGS SET WITH LOCK CYLINDER PROTECTION
- BERGEN AND BLOK SPLIT ESCUTCHEONS
- CLASS 5 LOCK CYLINDER, SINGLE KEY SYSTEM, BOLT LOCK

EXTRA CHARGES

ALUTHERM DOOR FRAME	AMSTERDAM / MONTREAL HANDRAIL ELECTRIC STRIKE RECOMMENDED	1800 mm
TWO-COLOUR DOOR		1700 mm
CLASS 6 LOCK CYLINDER, SINGLE KEY SYSTEM	AMSTERDAM / MONTREAL HANDRAIL WITH PUSHBUTTON, WITH DOOR LEAF ADJUSTMENT AND ELECTRIC STRIKE	1500 mm
UPPER ESCUTCHEON PROTECTION		1000 mm
KNOB-HANDLE	AMSTERDAM HANDRAIL WITH WIRELESS PUSHBUTTON	1700 mm
REED SWITCH	ELECTRIC STRIKE NECESSARY	1500 mm
SIZE 100E	DOOR SHORTENING (10, 20, 30, 40, 60, 80, 100 mm)	
ELECTRIC STRIKE WITH DAY / NIGHT FEATURE	TEDEE SET	

FIXED GLAZED SIDE PANELS: PAGES 88-89, FULL EQUIPMENT LIST: PAGES 94-99

GLASS

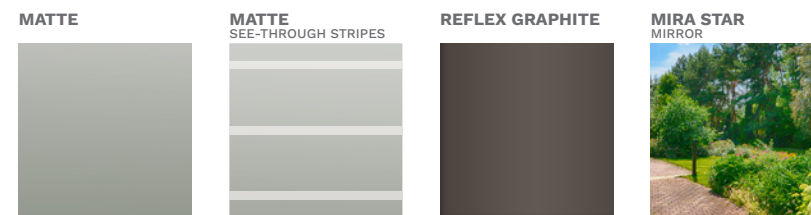

DOOR COLOURS

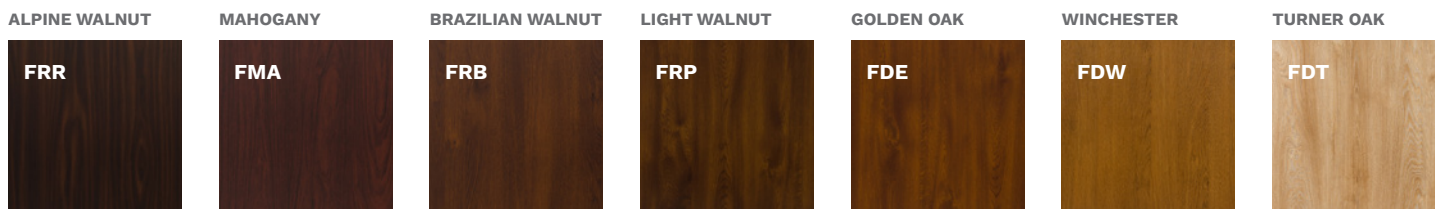



SNUB MILANO 4 B

FITTINGS

HANDLE-HANDLE



BERGEN

OPTIMA 60



BLOK



BERGEN

KNOB-HANDLE*

OPTIMA 60

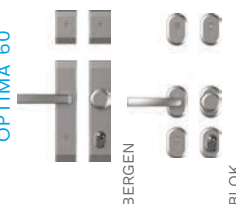

BERGEN

BLOK

HANDRAIL-HANDLE*

OPTIMA 60

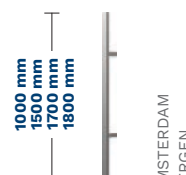

AMSTERDAM
BERGEN

FITTINGS' COLOURS

PLATINUM ANODE

SILVER ANODE

BLACK ANODE

DOOR COLOURS

LIGHT WENGE



FEJ

WHITE



FSB

STEEL GRAY

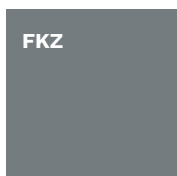

FKZ

ANTHRACITE

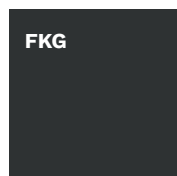

FKG

DARK ANTHRACITE

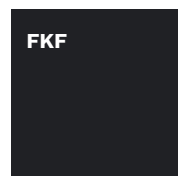

FKF

BLACK

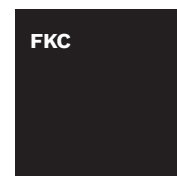

FKC

TWO-COLOUR DOOR*



INTERNAL

EXTERNAL

* EXTRA CHARGE



NT1 TURYN 1



NT1B TURYN 1 B

Door size	80N	80	90N	90E	100E
Door height (PERFOTHERM / ALUTHERM)	2076 / 2087 mm				

MODEL	OPTIMA 50	OPTIMA 60
NT1 TURYN 1	-	✓
NT1B TURYN 1 B	-	✓
NT2 TURYN 2	-	✓
NT2B TURYN 2 B	-	✓

RC2 STANDARD EQUIPMENT

- GLAZED DOOR LEAF
- 3 SIDES REBATED
- PERFOTHERM DOOR FRAME
- HINGES ADJUSTABLE IN TWO PLANES WITH CAPS MATCHING FITTING'S COLOUR
- DOUBLE-SIDED PATTERN
- ALUMINUM THRESHOLD
- FITTINGS SET WITH LOCK CYLINDER PROTECTION
- BERGEN AND BLOK SPLIT ESCUTCHEONS
- CLASS 5 LOCK CYLINDER, SINGLE KEY SYSTEM, BOLT LOCK

EXTRA CHARGES

ALUTHERM DOOR FRAME	AMSTERDAM / MONTREAL HANDRAIL ELECTRIC STRIKE RECOMMENDED	1800 mm
TWO-COLOUR DOOR		1700 mm
CLASS 6 LOCK CYLINDER, SINGLE KEY SYSTEM	AMSTERDAM / MONTREAL HANDRAIL WITH PUSHBUTTON, WITH DOOR LEAF ADJUSTMENT AND ELECTRIC STRIKE	1500 mm 1000 mm
UPPER ESCUTCHEON PROTECTION		
KNOB-HANDLE	AMSTERDAM HANDRAIL WITH WIRELESS PUSHBUTTON ELECTRIC STRIKE NECESSARY	1700 mm 1500 mm
REED SWITCH		
SIZE 100E	DOOR SHORTENING (10, 20, 30, 40, 60, 80, 100 mm)	
ELECTRIC STRIKE WITH DAY / NIGHT FEATURE	TEDEE SET	

FIXED GLAZED SIDE PANELS: PAGES 88-89, FULL EQUIPMENT LIST: PAGES 94-99

GLASS

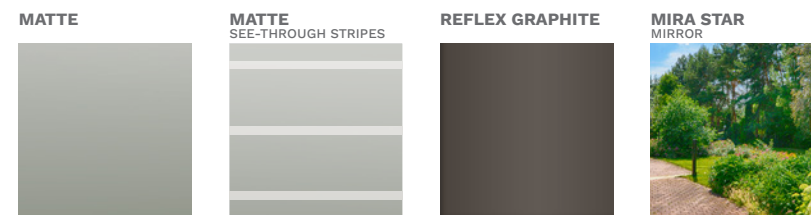

DOOR COLOURS

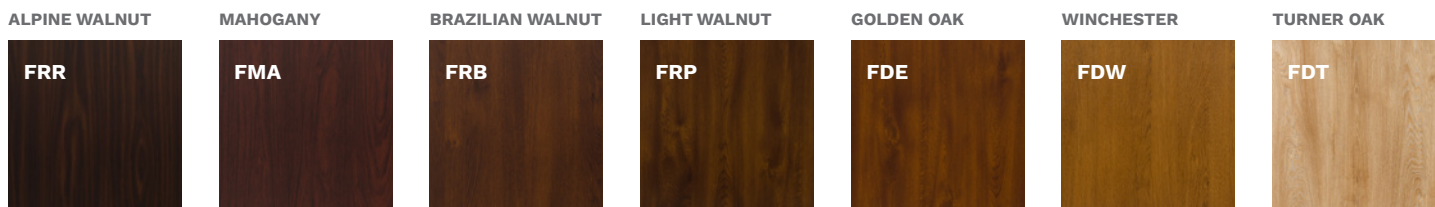



NT2 TURYN 2



NT2B TURYN 2 B

FITTINGS

HANDLE-HANDLE



BERGEN

OPTIMA 60



BLOK



BERGEN

KNOB-HANDLE*

OPTIMA 60

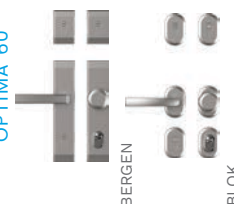

BERGEN

BLOK

HANDRAIL-HANDLE*

OPTIMA 60

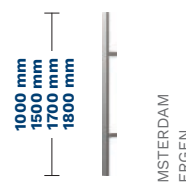

AMSTERDAM
BERGEN

FITTINGS' COLOURS

PLATINUM ANODE

SILVER ANODE

BLACK ANODE

DOOR COLOURS

LIGHT WENGE



FEJ

WHITE



FSB

STEEL GRAY

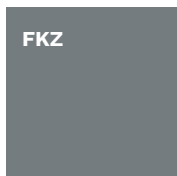

FKZ

ANTHRACITE

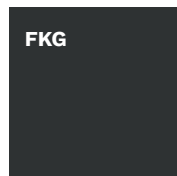

FKG

DARK ANTHRACITE

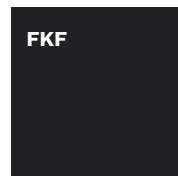

FKF

BLACK

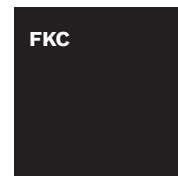

FKC

TWO-COLOUR DOOR*



INTERNAL

EXTERNAL

* EXTRA CHARGE

TEMPO BERGAMO / NICEA / BERLIN

GERDA®



SOJ BERGAMO 2



SJ9 NICEA 9

DOOR COLOURS

ALPINE WALNUT

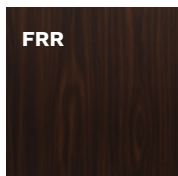

FRR

MAHOGANY

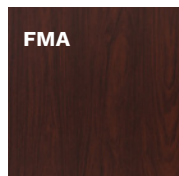

FMA

BRAZILIAN WALNUT

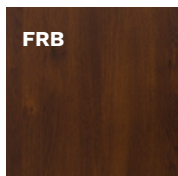

FRB

LIGHT WALNUT

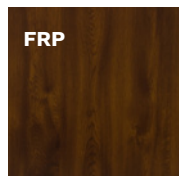

FRP

GOLDEN OAK

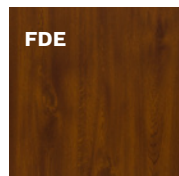

FDE

WINCHESTER

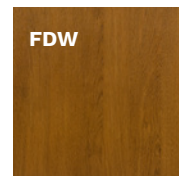

FDW

TURNER OAK



FDT

Door size	80N	80	90N	90E	100E
Door height (PERFOTHERM / ALUTHERM)	2076 / 2087 mm				
MODEL	OPTIMA 50		OPTIMA 60		
SOJ BERGAMO 2	-		✓		
SJ9 NICEA 9	-		✓		
SBE BERLIN	-		✓		

RC2 STANDARD EQUIPMENT

- GLAZED DOOR LEAF
- 3 SIDES REBATED
- PERFOTHERM DOOR FRAME
- HINGES ADJUSTABLE IN TWO PLANES WITH CAPS MATCHING FITTING'S COLOUR
- DOUBLE-SIDED PATTERN
- ALUMINUM THRESHOLD
- FITTINGS SET WITH LOCK CYLINDER PROTECTION
- BERGEN AND BLOK SPLIT ESCUTCHEONS
- CLASS 5 LOCK CYLINDER, SINGLE KEY SYSTEM, BOLT LOCK

EXTRA CHARGES

ALUTHERM DOOR FRAME	AMSTERDAM / MONTREAL HANDRAIL ELECTRIC STRIKE RECOMMENDED	1800 mm
TWO-COLOUR DOOR		1700 mm
CLASS 6 LOCK CYLINDER, SINGLE KEY SYSTEM	AMSTERDAM / MONTREAL HANDRAIL WITH PUSHBUTTON, WITH DOOR LEAF ADJUSTMENT AND ELECTRIC STRIKE	1500 mm 1000 mm
UPPER ESCUTCHEON PROTECTION		
KNOB-HANDLE	AMSTERDAM HANDRAIL WITH WIRELESS PUSHBUTTON ELECTRIC STRIKE NECESSARY	1700 mm 1500 mm
REED SWITCH		
SIZE 100E	DOOR SHORTENING SJ9 (10, 20, 30, 40 mm) SBE (10, 20, 30, 40, 60, 80, 100 mm)	
ELECTRIC STRIKE WITH DAY / NIGHT FEATURE	TEDEE SET	

FIXED GLAZED SIDE PANELS: PAGES 88-89, FULL EQUIPMENT LIST: PAGES 94-99

GLASS model BERGAMO / NICEA

MATTE

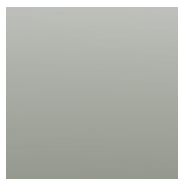

**MATTE
SEE-THROUGH STRIPES**

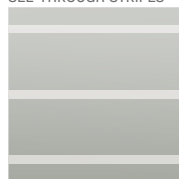

**MIRA STAR
MIRROR**

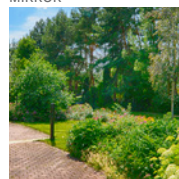



SBE BERLIN

GLASS model BERLIN

MATTE

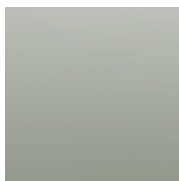

REFLEX BROWN



LIGHT WENGE



WHITE



STEEL GRAY

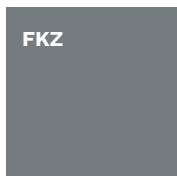

ANTHRACITE

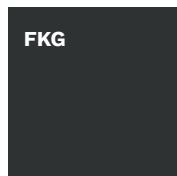

DARK ANTHRACITE

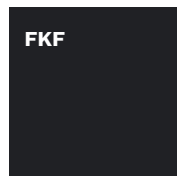

BLACK

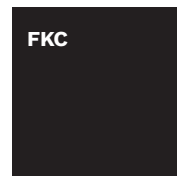

TWO-COLOUR DOOR*

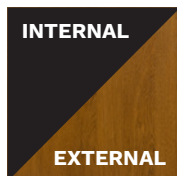

* EXTRA CHARGE

FITTINGS

HANDLE-HANDLE



BERGEN

OPTIMA 60



BLOK

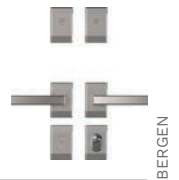

BERGEN

KNOB-HANDLE*

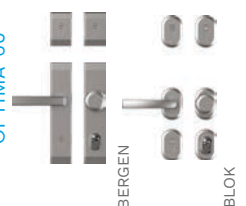

OPTIMA 60

BERGEN

BLOK

HANDRAIL-HANDLE*

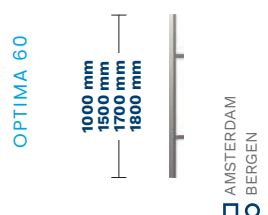

OPTIMA 60

AMSTERDAM
BERGEN

FITTINGS' COLOURS

PLATINUM ANODE

SILVER ANODE

BLACK ANODE

DOOR COLOURS



ST4 UPPSALA 1
(pressed without inserts)

Door size	80N	80	90N	90E	100E
Door height (FB, PERFOTHERM / ALUTHERM)	2076 / 2087 mm				

MODEL	OPTIMA 50	OPTIMA 60
ST4 UPPSALA 1	✓	✓
ST4A UPPSALA 1 A	✓	✓

RC2 STANDARD EQUIPMENT

• SOLID DOOR LEAF	• ALUMINUM THRESHOLD
• 3 SIDES REBATED	• FITTINGS SET WITH LOCK CYLINDER PROTECTION
• OPTIMA 60 – PERFOTHERM DOOR FRAME	• BERGEN AND BLOK SPLIT ESCUTCHEONS
• OPTIMA 50 – STEEL DOOR FRAME	• CLASS 5 LOCK CYLINDER, SINGLE KEY SYSTEM, BOLT LOCK
• HINGES ADJUSTABLE IN TWO PLANES WITH CAPS MATCHING FITTING'S COLOUR	• INSERTY INOX
• DOUBLE-SIDED PATTERN	

EXTRA CHARGES

OPTIMA 60 – ALUTHERM 60 DOOR FRAME		1800 mm
OPTIMA 50 – PERFOTHERM 50 DOOR FRAME	AMSTERDAM / MONTREAL HANDRAIL	1700 mm
TWO-COLOUR DOOR	ELECTRIC STRIKE RECOMMENDED	1500 mm
RC3 PACKAGE		1000 mm
CLASS 6 LOCK CYLINDER, SINGLE KEY SYSTEM	AMSTERDAM / MONTREAL	1800 mm
UPPER ESCUTCHEON PROTECTION	HANDRAIL WITH PUSHBUTTON, WITH DOOR LEAF ADJUSTMENT AND ELECTRIC STRIKE	1700 mm
KNOB-HANDLE		1500 mm
REED SWITCH		1000 mm
SIZE 100E	AMSTERDAM HANDRAIL WITH WIRELESS PUSHBUTTON	1700 mm
ELECTRIC STRIKE WITH DAY / NIGHT FEATURE	ELECTRIC STRIKE NECESSARY	1500 mm
	TEDEE SET	

FIXED GLAZED SIDE PANELS: PAGES 88–89, FULL EQUIPMENT LIST: PAGES 94–99

DOOR COLOURS

ALPINE WALNUT

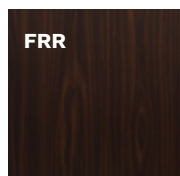

MAHOGANY

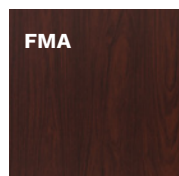

BRAZILIAN WALNUT

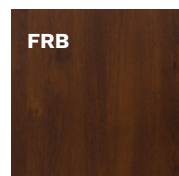

LIGHT WALNUT

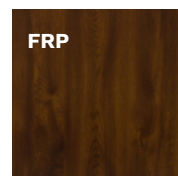

GOLDEN OAK

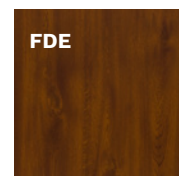

WINCHESTER

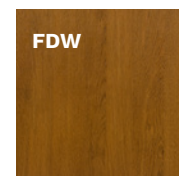

TURNER OAK





ST4A UPPSALA 1 A (INOX inserts)

FITTINGS

HANDLE-HANDLE



KNOB-HANDLE*

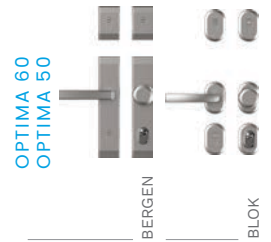

HANDRAIL-HANDLE*

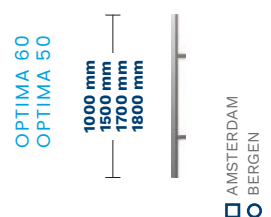

FITTINGS' COLOURS

PLATINUM ANODE

SILVER ANODE

BLACK ANODE

DOOR COLOURS

LIGHT WENGE



WHITE



STEEL GRAY

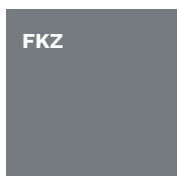

ANTHRACITE

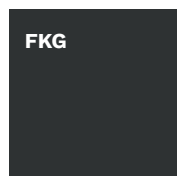

DARK ANTHRACITE

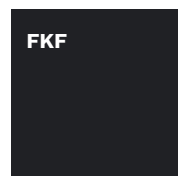

BLACK

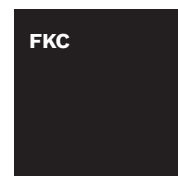

TWO-COLOUR DOOR*



* EXTRA CHARGE



TML TOKIO 1
(pressed without inserts)



TMLA TOKIO 1A (INOX inserts)

Door size	80N	80	90N	90E	100E
Door height (FB, PERFOTHERM / ALUTHERM)	2076 / 2087 mm				

MODEL	OPTIMA 50	OPTIMA 60
TML TOKIO 1	✓	✓
TMLA TOKIO 1 A	✓	✓
TMM TOKIO 2	✓	✓
TMMA TOKIO 2 A	✓	✓

RC2 STANDARD EQUIPMENT

- SOLID DOOR LEAF
- 3 DOOR LEAF UPSTANDS
- OPTIMA 50 – FB STEEL DOOR FRAME
OPTIMA 60 – PERFOTHERM DOOR FRAME
- DOUBLE-SIDED PATTERN
- 2D-ADJUSTABLE HINGES WITH CAPS MATCHING FITTING'S COLOUR
- ALUMINUM THRESHOLD
- FITTINGS SET WITH LOCK CYLINDER PROTECTION
- BERGEN AND BLOK SPLIT ESCUTCHEONS
- CLASS 5 LOCK CYLINDER, SINGLE KEY SYSTEM
- INSERTS **INOX**

EXTRA CHARGES

OPTIMA 60 – ALUTHERM 60 DOOR FRAME		1800 mm
OPTIMA 50 – PERFOTHERM 50 DOOR FRAME	AMSTERDAM / MONTREAL HANDRAIL	1700 mm
TWO-COLOUR DOOR	ELECTRIC STRIKE RECOMMENDED	1500 mm
RC3 PACKAGE		1000 mm
CLASS 6 LOCK CYLINDER, SINGLE KEY SYSTEM		1800 mm
UPPER ESCUTCHEON PROTECTION	AMSTERDAM / MONTREAL HANDRAIL WITH PUSHBUTTON, WITH DOOR LEAF ADJUSTMENT AND ELECTRIC STRIKE	1700 mm
KNOB-HANDLE		1500 mm
REED SWITCH		1000 mm
SIZE 100E	AMSTERDAM HANDRAIL WITH WIRELESS PUSHBUTTON	1700 mm
ELECTRIC STRIKE WITH DAY / NIGHT FEATURE	ELECTRIC STRIKE NECESSARY	1500 mm
	TEDEE SET	

FIXED GLAZED SIDE PANELS: PAGES 88-89, FULL EQUIPMENT LIST: PAGES 94-99

DOOR COLOURS

ALPINE WALNUT

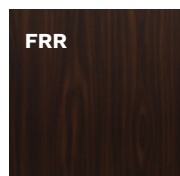

MAHOGANY

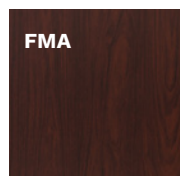

BRAZILIAN WALNUT

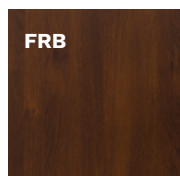

LIGHT WALNUT

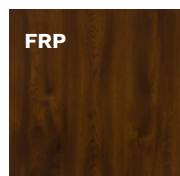

GOLDEN OAK

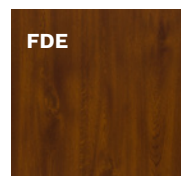

WINCHESTER

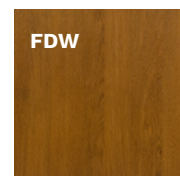

TURNER OAK





TMM TOKIO 2
(pressed without inserts)



TMMA TOKIO 2A (INOX inserts)

FITTINGS

HANDLE-HANDLE



KNOB-HANDLE*

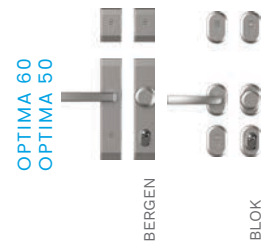

HANDRAIL-HANDLE*

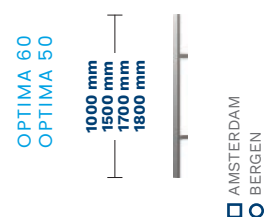

FITTINGS' COLOURS

PLATINUM ANODE

SILVER ANODE

BLACK ANODE

DOOR COLOURS

LIGHT WENGE



WHITE



STEEL GRAY

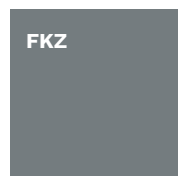

ANTHRACITE

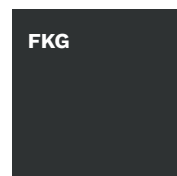

DARK ANTHRACITE

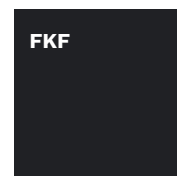

BLACK

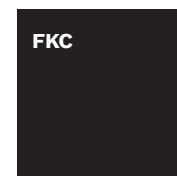

TWO-COLOUR DOOR*



* EXTRA CHARGE

TEMPO RYGA / LUND / ASPEN

GERDA®



ST8 RYGA



ST9 LUND

Door size	80N	80	90N	90E	100E
Door height (FB, PERFOTHERM / ALUTHERM)	2076 / 2087 mm				

MODEL	OPTIMA 50	OPTIMA 60
ST8 RYGA	✓	✓
ST9 LUND	✓	✓
WBA ASPEN 1	✓	✓
TN7 ASPEN 2	✓	✓
TN7B ASPEN 2 B	✓	✓

RC2 STANDARD EQUIPMENT

- SOLID DOOR LEAF
- 3 DOOR LEAF UPSTANDS
- OPTIMA 50 – FB STEEL DOOR FRAME
OPTIMA 60 – PERFOTHERM DOOR FRAME
- DOUBLE-SIDED PATTERN
- 2D-ADJUSTABLE HINGES WITH CAPS MATCHING FITTING'S COLOUR
- ALUMINUM THRESHOLD
- FITTINGS SET WITH LOCK CYLINDER PROTECTION
- BERGEN AND BLOK SPLIT ESCUTCHEONS
- CLASS 5 LOCK CYLINDER, SINGLE KEY SYSTEM
- INSERTS **INOX** **BLACK***

EXTRA CHARGES

*only for ASPEN

OPTIMA 60 – ALUTHERM 60 DOOR FRAME		1800 mm
OPTIMA 50 – PERFOTHERM 50 DOOR FRAME	AMSTERDAM / MONTREAL HANDRAIL	1700 mm
TWO-COLOUR DOOR	ELECTRIC STRIKE RECOMMENDED	1500 mm
RC3 PACKAGE		1000 mm
CLASS 6 LOCK CYLINDER, SINGLE KEY SYSTEM		1800 mm
UPPER ESCUTCHEON PROTECTION	AMSTERDAM / MONTREAL HANDRAIL WITH PUSHBUTTON, WITH DOOR LEAF ADJUSTMENT AND ELECTRIC STRIKE	1700 mm
KNOB-HANDLE		1500 mm
REED SWITCH		1000 mm
SIZE 100E	AMSTERDAM HANDRAIL WITH WIRELESS PUSHBUTTON	1700 mm
ELECTRIC STRIKE WITH DAY / NIGHT FEATURE	ELECTRIC STRIKE NECESSARY	1500 mm
DOOR SHORTENING WBA, TN7, TN7B (10, 20, 30, 40, 60, 80, 100 mm)	TEDEE SET	

FIXED GLAZED SIDE PANELS: PAGES 88–89, FULL EQUIPMENT LIST: PAGES 94–99

DOOR COLOURS

ALPINE WALNUT

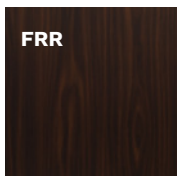

FRR

MAHOGANY

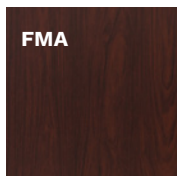

FMA

BRAZILIAN WALNUT

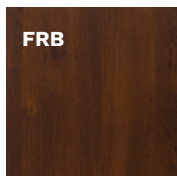

FRB

LIGHT WALNUT

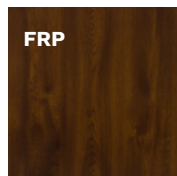

FRP

GOLDEN OAK

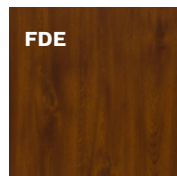

FDE

WINCHESTER

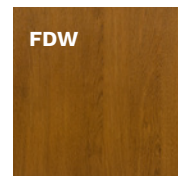

FDW

TURNER OAK



FDT



WBA ASPEN 1



TN7 ASPEN 2



TN7B ASPEN 2 B

FITTINGS

HANDLE-HANDLE



KNOB-HANDLE*

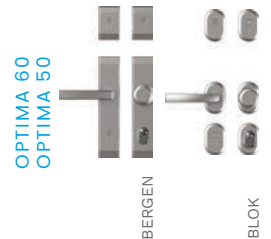

HANDRAIL-HANDLE*

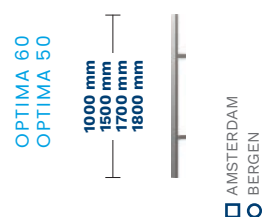

FITTINGS' COLOURS

PLATINUM ANODE

SILVER ANODE

BLACK ANODE

DOOR COLOURS

LIGHT WENGE



WHITE



STEEL GRAY

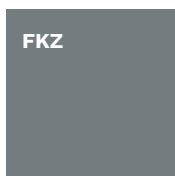

ANTHRACITE

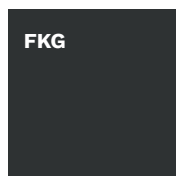

DARK ANTHRACITE

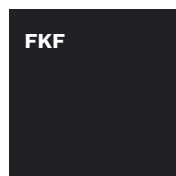

BLACK

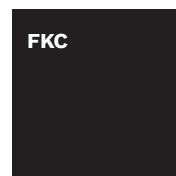

TWO-COLOUR DOOR*



* EXTRA CHARGE



SR3 TROMSO



SR4 TROMSO 1

Door size	80N	80	90N	90E	100E
Door height (FB, PERFOTHERM / ALUTHERM)	2076 / 2087 mm				

MODEL	OPTIMA 50	OPTIMA 60
SR3 TROMSO	✓	✓
SR4 TROMSO 1	✓	✓
SR5 TROMSO 2	✓	✓

RC2 STANDARD EQUIPMENT

• GLAZED DOOR LEAF	• ALUMINUM THRESHOLD
• 3 SIDES REBATED	• FITTINGS SET WITH LOCK CYLINDER PROTECTION
• OPTIMA 60 – PERFOTHERM DOOR FRAME	• BERGEN AND BLOK SPLIT ESCUTCHEONS
• OPTIMA 50 – STEEL DOOR FRAME	
• HINGES ADJUSTABLE IN TWO PLANES WITH CAPS MATCHING FITTING'S COLOUR	• CLASS 5 LOCK CYLINDER, SINGLE KEY SYSTEM, BOLT LOCK
• DOUBLE-SIDED PATTERN	

EXTRA CHARGES

OPTIMA 60 – ALUTHERM 60 DOOR FRAME		1800 mm
OPTIMA 50 – PERFOTHERM 50 DOOR FRAME	AMSTERDAM / MONTREAL HANDRAIL	1700 mm
TWO-COLOUR DOOR	ELECTRIC STRIKE RECOMMENDED	1500 mm
RC3 PACKAGE		1000 mm
CLASS 6 LOCK CYLINDER, SINGLE KEY SYSTEM		1800 mm
UPPER ESCUTCHEON PROTECTION	AMSTERDAM / MONTREAL HANDRAIL WITH PUSHBUTTON, WITH DOOR LEAF ADJUSTMENT AND ELECTRIC STRIKE	1700 mm
KNOB-HANDLE		1500 mm
REED SWITCH		1000 mm
SIZE 100E	AMSTERDAM HANDRAIL WITH WIRELESS PUSHBUTTON	1700 mm
ELECTRIC STRIKE WITH DAY / NIGHT FEATURE	ELECTRIC STRIKE NECESSARY	1500 mm
DOOR SHORTENING SR4 (10, 20, 30, 40 mm)	TEDEE SET	

FIXED GLAZED SIDE PANELS: PAGES 88–89, FULL EQUIPMENT LIST: PAGES 94–99

DOOR COLOURS

ALPINE WALNUT

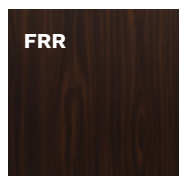

MAHOGANY

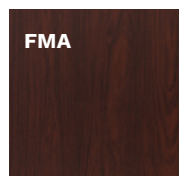

BRAZILIAN WALNUT

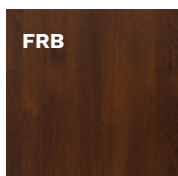

LIGHT WALNUT

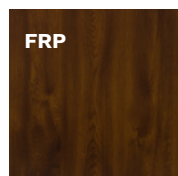

GOLDEN OAK

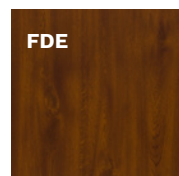

WINCHESTER

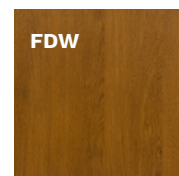

TURNER OAK





SR5 TROMSO 2

FITTINGS

HANDLE-HANDLE



KNOB-HANDLE*

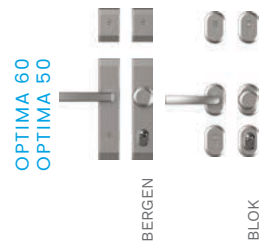

HANDRAIL-HANDLE*

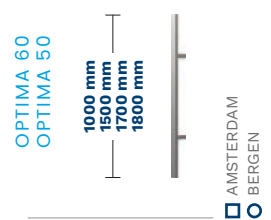

FITTINGS' COLOURS

PLATINUM ANODE

SILVER ANODE

BLACK ANODE

DOOR COLOURS

LIGHT WENGE



WHITE



STEEL GRAY

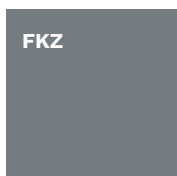

ANTHRACITE

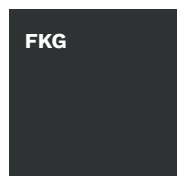

DARK ANTHRACITE

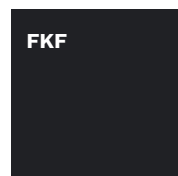

BLACK

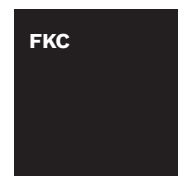

TWO-COLOUR DOOR*



* EXTRA CHARGE

CLASSIC MODENA / RAVENA

GERDA®



W76 MODENA



W77 MODENA 2

Door size	80	90N	90E
Door height (FB, PERFOTHERM / ALUTHERM)	2076 / 2087 mm		

MODEL	OPTIMA 50	OPTIMA 60
W76 MODENA	-	✓
W77 MODENA 2	-	✓
W78 MODENA 3	-	✓
WDR RAVENA	✓	✓

RC2 STANDARD EQUIPMENT

- GLAZED DOOR LEAF
- 3 SIDES REBATED
- OPTIMA 60 – PERFOTHERM DOOR FRAME
- OPTIMA 50 – STEEL DOOR FRAME
- HINGES ADJUSTABLE IN TWO PLANES WITH CAPS MATCHING FITTING'S COLOUR
- DOUBLE-SIDED PATTERN
- ALUMINUM THRESHOLD
- FITTINGS SET WITH LOCK CYLINDER PROTECTION
- BERGEN AND BLOK SPLIT ESCUTCHEONS
- CLASS 5 LOCK CYLINDER, SINGLE KEY SYSTEM, BOLT LOCK
- DEEP STAMPING

EXTRA CHARGES

OPTIMA 60 – ALUTHERM 60 DOOR FRAME	KNOB-HANDLE
OPTIMA 50 – PERFOTHERM 50 DOOR FRAME	REED SWITCH
TWO-COLOUR DOOR	ELECTRIC STRIKE WITH DAY / NIGHT FEATURE
RC3 PACKAGE (OPTIMA 60 WDR)	DOOR SHORTENING (10, 20, 30, 40, 60, 80, 100 mm)
CLASS 6 LOCK CYLINDER, SINGLE KEY SYSTEM	TEDEE SET
UPPER ESCUTCHEON PROTECTION	

FIXED GLAZED SIDE PANELS: PAGES 88–89, FULL EQUIPMENT LIST: PAGES 94–99

GLASS



DOOR COLOURS

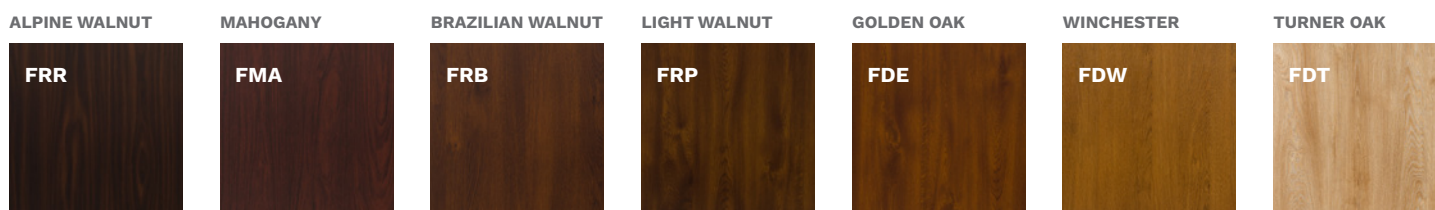



W78 MODENA 3



WDR RAVENA

FITTINGS

HANDLE-HANDLE



OPTIMA 60

BERGEN

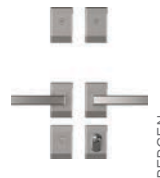

OPTIMA 60
OPTIMA 50

BERGEN



BLOK

KNOB-HANDLE*



OPTIMA 60

BERGEN



OPTIMA 60
OPTIMA 50

BERGEN



BLOK

FITTINGS' COLOURS

PLATINUM ANODE

SILVER ANODE

BLACK ANODE

DOOR COLOURS

LIGHT WENGE



FEJ

WHITE



FSB

STEEL GRAY



FKZ

ANTHRACITE

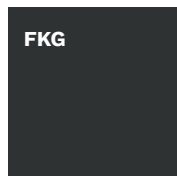

FKG

DARK ANTHRACITE

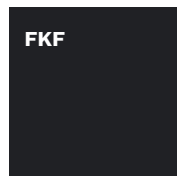

FKF

BLACK

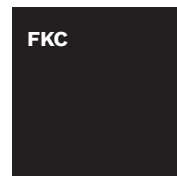

FKC

TWO-COLOUR DOOR*



INTERNAL

EXTERNAL

* EXTRA CHARGE

CLASSIC NICEA / OLYMPIA



WJ1 NICEA 5

Door size	80	90N	90E
Door height (FB, PERFOTHERM / ALUTHERM)	2076 / 2087 mm		

MODEL	OPTIMA 50	OPTIMA 60
WJ1 NICEA 5	-	✓
W23 OLYMPIA	-	✓

RC2 STANDARD EQUIPMENT

• GLAZED DOOR LEAF	• ALUMINUM THRESHOLD
• 3 SIDES REBATED	• FITTINGS SET WITH LOCK CYLINDER PROTECTION
• PERFOTHERM 60 DOOR FRAME	• BERGEN AND BLOK SPLIT ESCUTCHEONS
• HINGES ADJUSTABLE IN TWO PLANES WITH CAPS MATCHING FITTING'S COLOUR	• CLASS 5 LOCK CYLINDER, SINGLE KEY SYSTEM, BOLT LOCK
• DOUBLE-SIDED PATTERN	• DEEP STAMPING

EXTRA CHARGES

OPTIMA 60 – ALUTHERM 60 DOOR FRAME	REED SWITCH
TWO-COLOUR DOOR	SIZE 100E (W23)
CLASS 6 LOCK CYLINDER, SINGLE KEY SYSTEM	ELECTRIC STRIKE WITH DAY / NIGHT FEATURE
UPPER ESCUTCHEON PROTECTION	DOOR SHORTENING (10, 20, 30, 40, 60, 80, 100 mm)
KNOB-HANDLE	TEDEE SET

FIXED GLAZED SIDE PANELS: PAGES 88–89, FULL EQUIPMENT LIST: PAGES 94–99

GLASS

MATTE

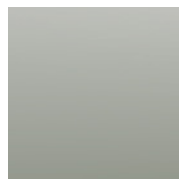

REFLEX GRAPHITE



MIRA STAR
MIRROR

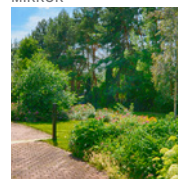

DOOR COLOURS

ALPINE WALNUT

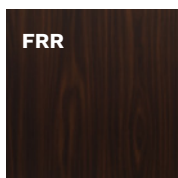

MAHOGANY

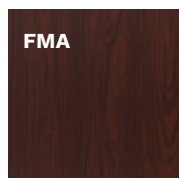

BRAZILIAN WALNUT

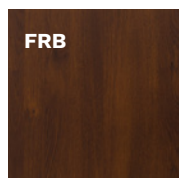

LIGHT WALNUT

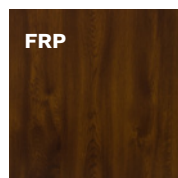

GOLDEN OAK

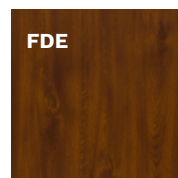

WINCHESTER

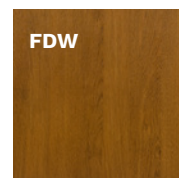

TURNER OAK





W23 OLYMPIA

FITTINGS

HANDLE-HANDLE



BERGEN

OPTIMA 60

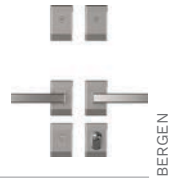

BERGEN



BLOK

KNOB-HANDLE*



BERGEN

OPTIMA 60



BERGEN



BLOK

FITTINGS' COLOURS

PLATINUM ANODE

SILVER ANODE

BLACK ANODE

DOOR COLOURS

LIGHT WENGE



WHITE



STEEL GRAY



ANTHRACITE

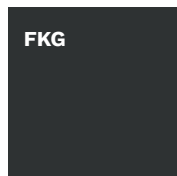

DARK ANTHRACITE

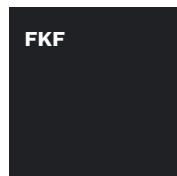

BLACK

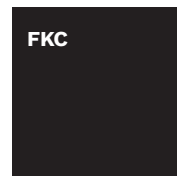

TWO-COLOUR DOOR*



* EXTRA CHARGE



W91 WERONA



W94 WERONA 1

DOOR COLOURS

ALPINE WALNUT

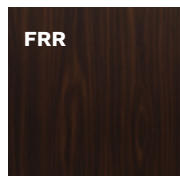

FRR

MAHOGANY

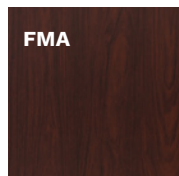

FMA

BRAZILIAN WALNUT

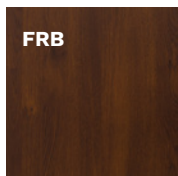

FRB

LIGHT WALNUT

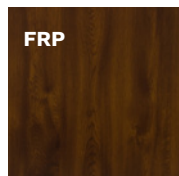

FRP

GOLDEN OAK

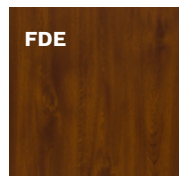

FDE

WINCHESTER

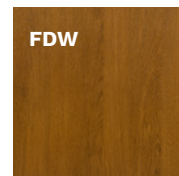

FDW

TURNER OAK



FDT

Door size

80

90N

90E

Door height
(FB, PERFOTHERM / ALUTHERM)

2076 / 2087 mm

MODEL

OPTIMA 50

OPTIMA 60

W91 WERONA

✓

✓

W94 WERONA 1

-

✓

W93 WERONA 3

-

✓

W6A WERONA 4

-

✓

WQA WERONA 5

-

✓

RC2 STANDARD EQUIPMENT

- GLAZED DOOR LEAF
- 3 SIDES REBATED
- OPTIMA 60 – PERFOTHERM DOOR FRAME
- OPTIMA 50 – STEEL DOOR FRAME
- HINGES ADJUSTABLE IN TWO PLANES WITH CAPS MATCHING FITTING'S COLOUR
- DOUBLE-SIDED PATTERN
- ALUMINUM THRESHOLD
- FITTINGS SET WITH LOCK CYLINDER PROTECTION
- BERGEN AND BLOK SPLIT ESCUTCHEONS
- CLASS 5 LOCK CYLINDER, SINGLE KEY SYSTEM, BOLT LOCK
- DEEP STAMPING

EXTRA CHARGES

OPTIMA 60 – ALUTHERM 60 DOOR FRAME

KNOB-HANDLE

OPTIMA 50 – PERFOTHERM 50 DOOR FRAME

REED SWITCH

TWO-COLOUR DOOR

ELECTRIC STRIKE WITH DAY / NIGHT FEATURE

RC3 PACKAGE (OPTIMA 60 W91)

DOOR SHORTENING
(10, 20, 30, 40, 60, 80, 100 mm)

CLASS 6 LOCK CYLINDER, SINGLE KEY SYSTEM

UPPER ESCUTCHEON PROTECTION

TEDEE SET

FIXED GLAZED SIDE PANELS: PAGES 88–89, FULL EQUIPMENT LIST: PAGES 94–99

GLASS

MATTE

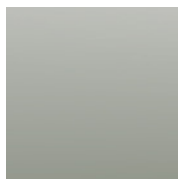

REFLEX BROWN



MIRA STAR
MIRROR

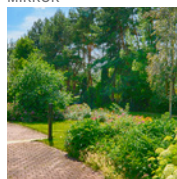



W93 WERONA 3



W6A WERONA 4



WQA WERONA 5

FITTINGS

HANDLE-HANDLE



KNOB-HANDLE*

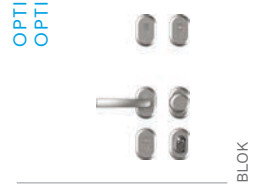
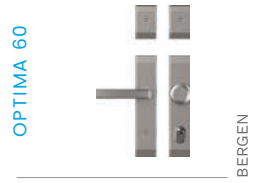

FITTINGS' COLOURS



DOOR COLOURS

LIGHT WENGE



WHITE



STEEL GRAY



ANTHRACITE

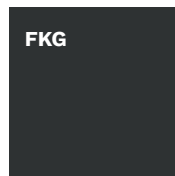

DARK ANTHRACITE

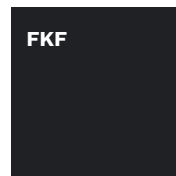

BLACK

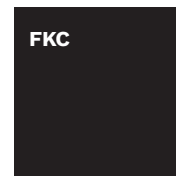

TWO-COLOUR DOOR*

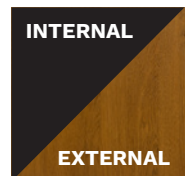

* EXTRA CHARGE

CLASSIC LIZBONA / WENECJA / LONDYN

GERDA®



W24 LIZBONA



W9N WENECJA

DOOR COLOURS

ALPINE WALNUT

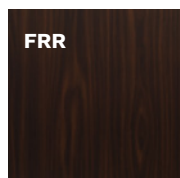

FRR

MAHOGANY

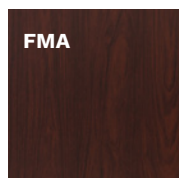

FMA

BRAZILIAN WALNUT

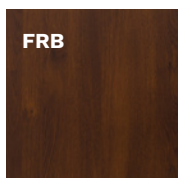

FRB

LIGHT WALNUT

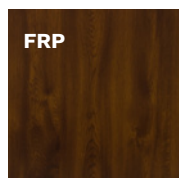

FRP

GOLDEN OAK

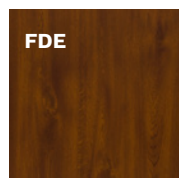

FDE

WINCHESTER

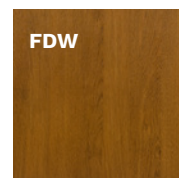

FDW

TURNER OAK



FDT

Door size	80	90N	90E
Door height (FB, PERFOTHERM / ALUTHERM)	2076 / 2087 mm		

MODEL	OPTIMA 50	OPTIMA 60
W24 LIZBONA	✓	✓
W9N WENECJA	✓	✓
W13 LONDYN	✓	✓
W5L LONDYN 1	-	✓

RC2 STANDARD EQUIPMENT

- GLAZED DOOR LEAF
- 3 SIDES REBATED
- OPTIMA 60 – PERFOTHERM DOOR FRAME
- OPTIMA 50 – STEEL DOOR FRAME
- HINGES ADJUSTABLE IN TWO PLANES WITH CAPS MATCHING FITTING'S COLOUR
- DOUBLE-SIDED PATTERN
- ALUMINUM THRESHOLD
- FITTINGS SET WITH LOCK CYLINDER PROTECTION
- BERGEN AND BLOK SPLIT ESCUTCHEONS
- CLASS 5 LOCK CYLINDER, SINGLE KEY SYSTEM, BOLT LOCK
- DEEP STAMPING

EXTRA CHARGES

OPTIMA 60 – ALUTHERM 60 DOOR FRAME	KNOB-HANDLE
OPTIMA 50 – PERFOTHERM 50 DOOR FRAME	REED SWITCH
TWO-COLOUR DOOR	ELECTRIC STRIKE WITH DAY / NIGHT FEATURE
RC3 PACKAGE (OPTIMA 60 W24, W9N, W13)	DOOR SHORTENING (10, 20, 30, 40, 60, 80, 100 mm)
CLASS 6 LOCK CYLINDER, SINGLE KEY SYSTEM	TEDEE SET
UPPER ESCUTCHEON PROTECTION	

FIXED GLAZED SIDE PANELS: PAGES 88–89, FULL EQUIPMENT LIST: PAGES 94–99

GLASS

MATTE

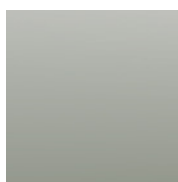

REFLEX BROWN



MIRA STAR
MIRROR

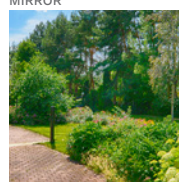



W13 LONDYN



W5L LONDYN 1

FITTINGS

HANDLE-HANDLE



KNOB-HANDLE*



FITTINGS' COLOURS

PLATINUM ANODE

SILVER ANODE

BLACK ANODE

DOOR COLOURS

LIGHT WENGE



WHITE



STEEL GRAY

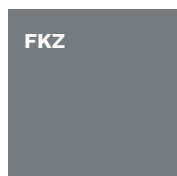

ANTHRACITE

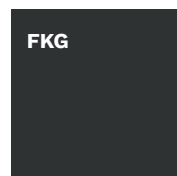

DARK ANTHRACITE

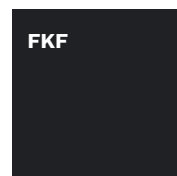

BLACK

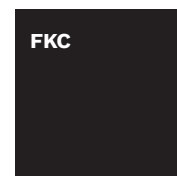

TWO-COLOUR DOOR*

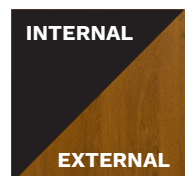

* EXTRA CHARGE

CLASSIC BARCELONA / GENEWA

GERDA®



W54 BARCELONA



W53 BARCELONA 1

DOOR COLOURS

ALPINE WALNUT

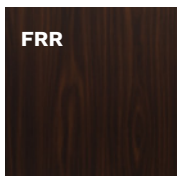

FRR

MAHOGANY

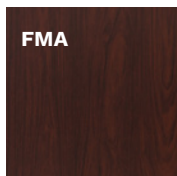

FMA

BRAZILIAN WALNUT

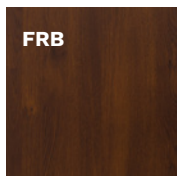

FRB

LIGHT WALNUT

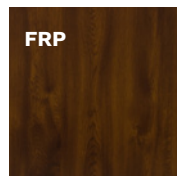

FRP

GOLDEN OAK

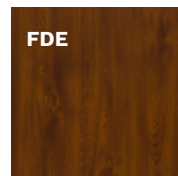

FDE

WINCHESTER

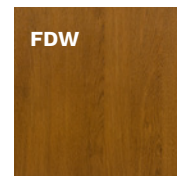

FDW

TURNER OAK



FDT

Door size	80	90N	90E
Door height (FB, PERFOTHERM / ALUTHERM)	2076 / 2087 mm		

MODEL	OPTIMA 50	OPTIMA 60
W54 BARCELONA	✓	✓
W53 BARCELONA 1	-	✓
G76 GENEWA 1	-	✓
G75 GENEWA 2	-	✓
D75 GENEWA 3	✓	✓

RC2 STANDARD EQUIPMENT

- GLAZED DOOR LEAF
- 3 SIDES REBATED
- OPTIMA 60 – PERFOTHERM DOOR FRAME
- OPTIMA 50 – STEEL DOOR FRAME
- HINGES ADJUSTABLE IN TWO PLANES WITH CAPS MATCHING FITTING'S COLOUR
- DOUBLE-SIDED PATTERN
- ALUMINUM THRESHOLD
- FITTINGS SET WITH LOCK CYLINDER PROTECTION
- BERGEN AND BLOK SPLIT ESCUTCHEONS
- CLASS 5 LOCK CYLINDER, SINGLE KEY SYSTEM, BOLT LOCK
- DEEP STAMPING (BARCELONA)

EXTRA CHARGES

OPTIMA 60 – ALUTHERM 60 DOOR FRAME	KNOB-HANDLE
OPTIMA 50 – PERFOTHERM 50 DOOR FRAME	REED SWITCH
TWO-COLOUR DOOR	ELECTRIC STRIKE WITH DAY / NIGHT FEATURE
RC3 PACKAGE (OPTIMA 60 W54, D75)	DOOR SHORTENING (10, 20, 30, 40, 60, 80, 100 mm)
CLASS 6 LOCK CYLINDER, SINGLE KEY SYSTEM	TEDEE SET
UPPER ESCUTCHEON PROTECTION	

FIXED GLAZED SIDE PANELS: PAGES 88–89, FULL EQUIPMENT LIST: PAGES 94–99

GLASS

MATTE

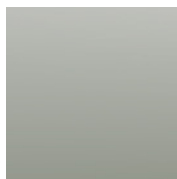

REFLEX BROWN



MIRA STAR
MIRROR

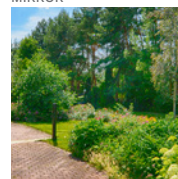



G76 GENEWA 1



G75 GENEWA 2



D75 GENEWA 3

FITTINGS

HANDLE-HANDLE

OPTIMA 60



BERGEN

OPTIMA 60
OPTIMA 50



BERGEN



BLOK

KNOB-HANDLE*

OPTIMA 60

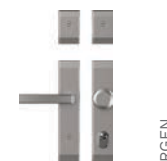

BERGEN

OPTIMA 60
OPTIMA 50



BERGEN



BLOK

FITTINGS' COLOURS

PLATINUM ANODE

SILVER ANODE

BLACK ANODE

DOOR COLOURS

LIGHT WENGE



FEJ

WHITE



FSB

STEEL GRAY

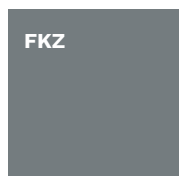

FKZ

ANTHRACITE

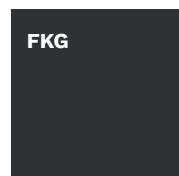

FKG

DARK ANTHRACITE

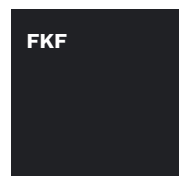

FKF

BLACK

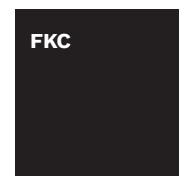

FKC

TWO-COLOUR DOOR*



INTERNAL

EXTERNAL

* EXTRA CHARGE

OPTIMA 60 DUO have been designed for users looking for a custom-size door. A passive door leaf enables a broader passage. Passive door leaves are available both with and without glazing.

PARAMETERS

- ✓ DOOR FOR DETACHED HOUSES AS WELL AS FOR MULTI-FAMILY HOUSES
- ✓ STEEL DOOR LEAVES 60 mm THICK, FILLED WITH EXPANDED GRAPHITE POLYSTYRENE
- ✓ AVAILABLE WITH PERFOATHERM 60 DOOR FRAME AND ALUMINUM THRESHOLD
- ✓ ALUTHERM 60 ALUMINUM DOOR FRAME WITH AN EXTRA CHARGE
- ✓ PASSIVE DOOR LEAVES IN SOLID AND GLAZED DESIGN, IN SIZES 30, 40, 50 cm
- ✓ DOOR AVAILABLE IN 12 COLOURS

DOOR FRAME DIMENSIONS AND MOUNTING HOLES – SEE p. 104–105

PASSIVE DOOR DESIGNS*

The passive door leaf price includes price for treshold and door frame. Alutherm 60 aluminum door frame – EXTRA CHARGE

NAME	SIZE
P00	30 40 50
PD4	40
GH1	40 50
GC2	40 50
GN5	30 40 50
GPD	30 40 50
DN3 / DN3B	30 40 50
DN6 / DN6B	30 40 50
DT8 / DT8B	50
DW9 / DW9B	50
DW8 / DW8B	50
DPE / DPEB	30 40 50
PD5	30 40 50
PD5A	30 40 50
PD5B	30 40 50
NMB	30 40 50
NMBA	30 40 50
NMBB	30 40 50
NMA	30 40 50
NMAA	30 40 50
NMAB	30 40 50

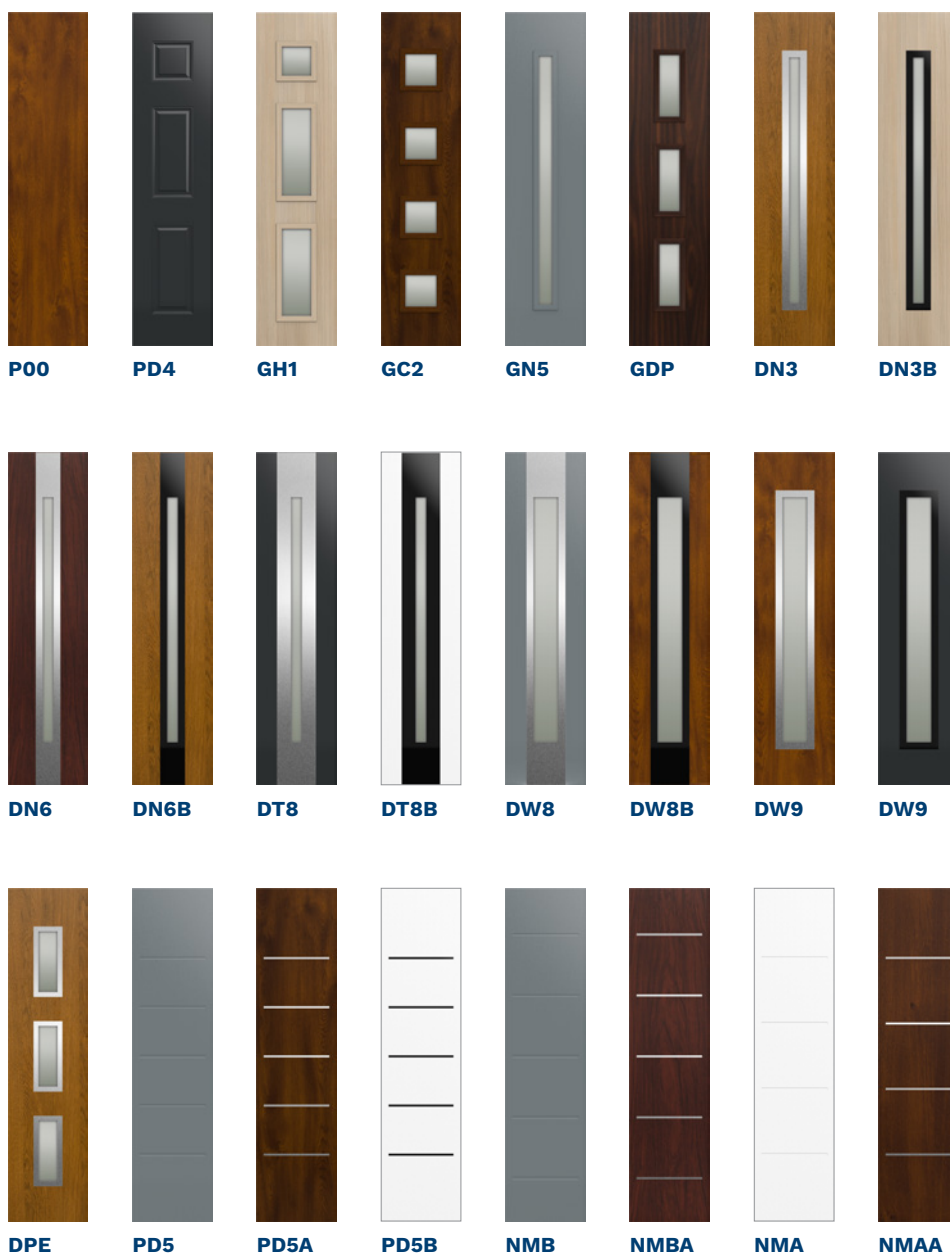



SOJ BERGAMO 2 + NMBA



NS5 HANOVER 5 + DW9



ST8 RYGA + P00



TMMA TOKIO 2 A + P00



NS9 MILANO 12 + DW8



SNUA MILANO 4 A + PD5A



NT2B TURYN 2 B + DT8



ST4A UPPSALA 1 A + NMAA



NS6 HANOVER 6 + DW8

* EXTRA CHARGE

ALUMINUM GLAZED SIDE AND TOP PANELS

GERDA®



SET GL



SET G



SET GP



SET L

SIDE GLAZED PANELS*

HEIGHT Hz	GLAZED PANEL / GLASS TYPE	WIDTH Ld/Pd						
		up to 300 mm	up to 400 mm	up to 500 mm	up to 600 mm	up to 700 mm	up to 800 mm	up to 900 mm
2087 mm	PANEL WITH SAFETY GLASS	✓	✓	✓	✓	✓	✓	✓
	ANTI-BULGLARY RC2 PANEL WITH P4 GLASS	✓	✓	✓	✓	✓	✓	✓
do 2200 mm	PANEL WITH SAFETY GLASS	✓	✓	✓	✓	✓	✓	✓
	ANTI-BULGLARY RC2 PANEL WITH P4 GLASS	✓	✓	✓	✓	✓	✓	✓
do 2300 mm	PANEL WITH SAFETY GLASS	✓	✓	✓	✓	✓	✓	✓
	ANTI-BULGLARY RC2 PANEL WITH P4 GLASS	✓	✓	✓	✓	✓	✓	✓
do 2400 mm	PANEL WITH SAFETY GLASS	✓	✓	✓	✓	✓	✓	✓
	ANTI-BULGLARY RC2 PANEL WITH P4 GLASS	✓	✓	✓	✓	✓	✓	✓

SIDE GLAZED PANEL STANDARD WIDTH IN 50 mm INCREMENTS. FOR 10 mm INCREMENTS – EXTRA CHARGE +25%

ALUTHERM DOOR FRAME

SIZE	HEIGHT Hz	WIDTH Sc
80	standard 2087 mm not standard:	918 mm
90N	2150 mm	988 mm
	2200 mm	
90E	2250 mm	1031 mm
	2300 mm	
100E	2350 mm	1131 mm
	2400 mm	

To get complete price for set please sum up:

for THERMO PRIME:

- door price
- side / top panel price

for THERMO PREMIUM I OPTIMA:

- door price
- ALUTHERM door frame extra charge,
- side / top panel price

GERDA[®] ALUMINUM GLAZED SIDE AND TOP PANELS



SET P



SET LP



SET LGP

TOP GLAZED PANELS*

HEIGHT Hd	GLAZED PANEL / GLASS TYPE	WIDTH Ld/B/Pd				
		up to 1150 mm	up to 1550 mm	up to 1950 mm	up to 2350 mm	up to 2950 mm
300 mm	PANEL WITH SAFETY GLASS	✓	✓	✓	✓	✓
400 mm		✓	✓	✓	✓	✓
500 mm		✓	✓	✓	✓	✓
300 mm	ANTI-BULGLARY RC2 PANEL WITH P4 GLASS	✓	✓	✓	✓	✓
400 mm		✓	✓	✓	✓	✓
500 mm		✓	✓	✓	✓	✓

SIDE GLAZED PANEL STANDARD WIDTH IN 50 mm INCREMENTS. FOR 10 mm INCREMENTS – EXTRA CHARGE +25%



A VARIETY OF COLOURS

GERDA®

CHOOSE YOUR DOOR COLOUR

ALPINE WALNUT

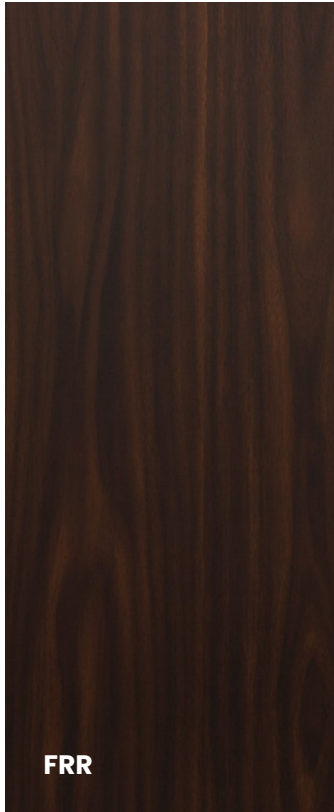

MAHOGANY

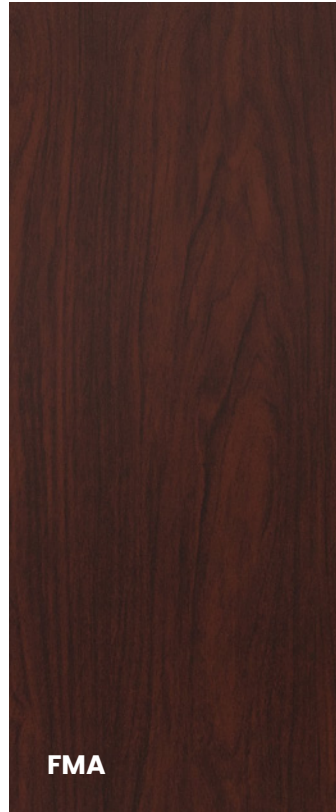

BRAZILIAN WALNUT

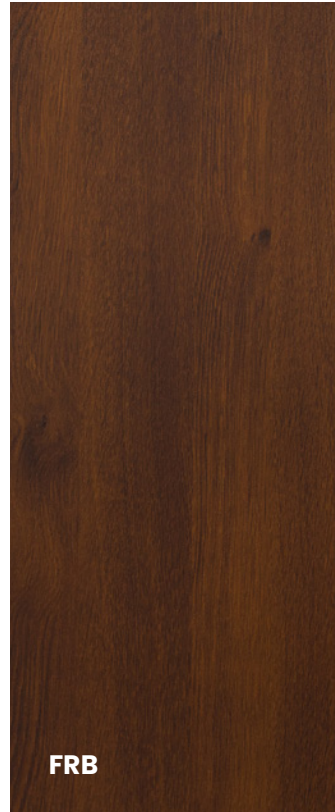

LIGHT WALNUT



WHITE

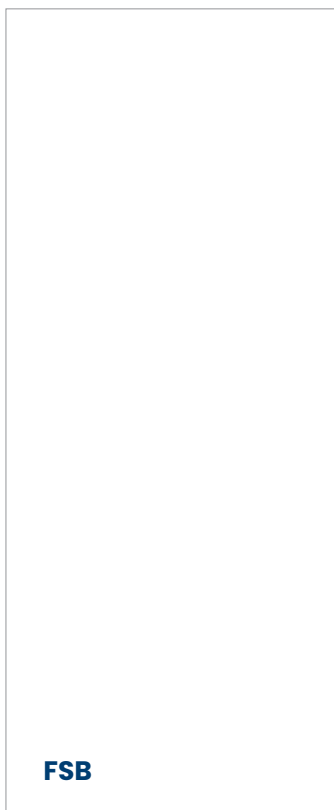

STEEL GRAY

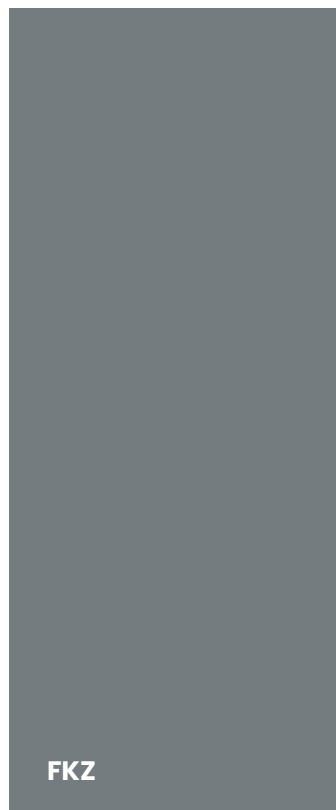

ANTHRACITE

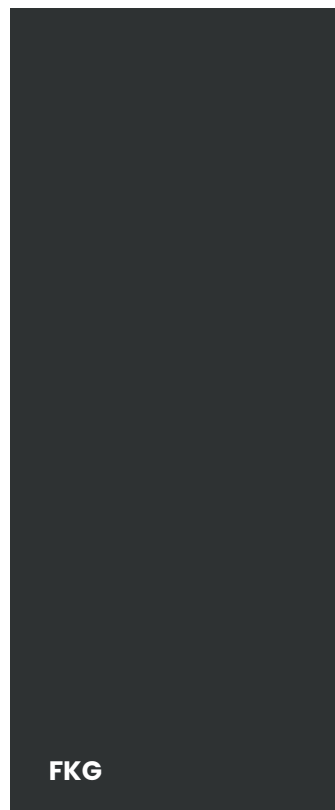

DARK ANTHRACITE



GOLDEN OAK

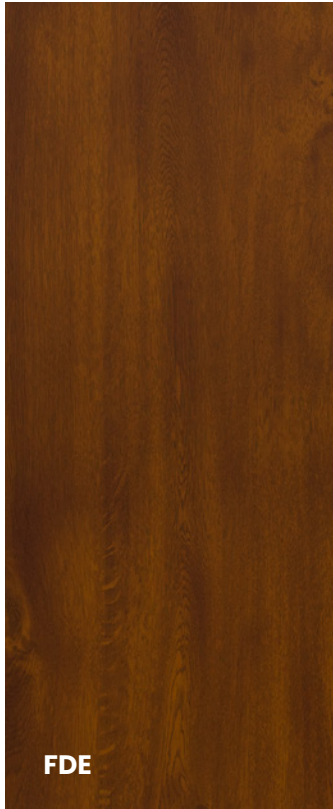

WINCHESTER

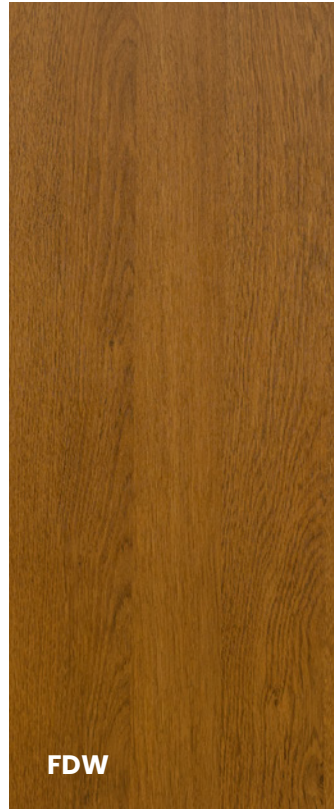

TURNER OAK



LIGHT WENGE



BLACK



TWO-COLOUR*



To obtain a unique configuration of the door to our house, we can combine any two colors from the available palette. The outer side of the door leaf, as well as the outer frame, will then have a different color than the inner side. In this way, we can even better match the style of the door to the design of the façade and interior. That option is available with an extra charge.

Without extra charges, there is also available to order door leaf in a selected color with a frame in a different color.

FITTINGS SET

GERDA®

**HANDLE-HANDLE
SOFIA ESCUTCHEON**



**HANDLE-HANDLE
TW300 BERGEN
SPLIT ESCUTCHEON
(ALEX HANDLE)**



**HANDRAIL-HANDLE
RING ESCUTCHEON,
BERGEN SPLIT ESCUTCHEON
(ALEX HANDLE)**



**HANDLE-HANDLE
TD200 BERGEN
LONG ESCUTCHEON
(BETA HANDLE)
BERGEN UPPER ESCUTCHEON**



ESCUTCHEON COLOURS



PLATINUM ANODE



SILVER ANODE



BLACK ANODE

LOCK CYLINDER COLOURS



NICKEL



BLACK

THERMO PRIME / THERMO PREMIUM STANDARD ACCESSORIES SET

THERMO PRIME CLASS 5 LOCK CYLINDER / THERMO PREMIUM CLASS 5 LOCK CYLINDER IN SINGLE KEY SYSTEM

5 KEYS + INSTALLER KEYS

MAIN LOCK ESCUTCHEON WITH PROTECTION (DECORATIVE RING ESCUTCHEON FOR DOORS WITH HANDRAIL)

ADDITIONAL LOCK ESCUTCHEON WITHOUT PROTECTION (THERMO PREMIUM)

HINGE CAPS MATCHING FITTING'S COLOUR

EXTRA CHARGES

ADDITIONAL LOCK ESCUTCHEON WITH PROTECTION (THERMO PREMIUM)

HANDLE-KNOB

CLASS 6 LOCK CYLINDERS IN A SINGLE KEY SYSTEM

CLASS 5 MAIN LOCK CYLINDER / CLASS 2 ADDITIONAL LOCK CYLINDER (THERMO PREMIUM)

ADJUSTMENT FOR HANDRAIL WITH A BUTTON

AMSTERDAM / MONTREAL HANDRAIL, ELECTRIC STRIKE RECOMMENDED, 1800 mm

AMSTERDAM / MONTREAL HANDRAIL, ELECTRIC STRIKE RECOMMENDED, 1700 mm

AMSTERDAM / MONTREAL HANDRAIL, ELECTRIC STRIKE RECOMMENDED, 1500 mm

AMSTERDAM / MONTREAL HANDRAIL, ELECTRIC STRIKE RECOMMENDED, 1000 mm

AMSTERDAM / MONTREAL HANDRAIL WITH PUSHBUTTON, WITH DOOR LEAF ADJUSTMENT AND ELECTRIC STRIKE, 1800 mm

AMSTERDAM / MONTREAL HANDRAIL WITH PUSHBUTTON, WITH DOOR LEAF ADJUSTMENT AND ELECTRIC STRIKE, 1700 mm

AMSTERDAM / MONTREAL HANDRAIL WITH PUSHBUTTON, WITH DOOR LEAF ADJUSTMENT AND ELECTRIC STRIKE, 1500 mm

AMSTERDAM / MONTREAL HANDRAIL WITH PUSHBUTTON, WITH DOOR LEAF ADJUSTMENT AND ELECTRIC STRIKE, 1000 mm

AMSTERDAM HANDRAIL WITH WIRELESS PUSHBUTTON ELECTRIC STRIKE NECESSARY, 1700 mm

AMSTERDAM HANDRAIL WITH WIRELESS PUSHBUTTON ELECTRIC STRIKE NECESSARY, 1500 mm

ROSTOCK HANDRAIL 2000 mm (ONLY FOR OUTWARD-OPENING DOORS)

TEDEE SET

**KNOB-HANDLE
TD200 BERGEN
LONG ESCUTCHEON
(ALEX HANDLE)
BERGEN UPPER ESCUTCHEON**



**HANDLE-HANDLE
TW200 BLOK SPLIT
ESCUTCHEON
(BETA HANDLE)
BLOK UPPER ESCUTCHEON**



**HANDLE-HANDLE
TW300 BERGEN SPLIT
ESCUTCHEON
(ALEX HANDLE)
BERGEN UPPER ESCUTCHEON**



**HANDRAIL-HANDLE
TW200 BLOK
SPLIT ESCUTCHEON
(BETA HANDLE)
BLOK UPPER ESCUTCHEON**



ESCUTCHEON COLOURS



LOCK CYLINDER COLOURS



OPTIMA STANDARD ACCESSORIES SET

CLASS 5 LOCK CYLINDER IN SINGLE KEY SYSTEM

5 KEYS + INSTALLER KEYS

MAIN LOCK ESCUTCHEON WITH PROTECTION

ADDITIONAL LOCK ESCUTCHEON WITHOUT PROTECTION

HINGE CAPS MATCHING FITTING'S COLOUR

EXTRA CHARGES

ADDITIONAL LOCK ESCUTCHEON WITH PROTECTION

HANDLE-KNOB

CLASS 6 LOCK CYLINDERS IN A SINGLE KEY SYSTEM

CLASS 2 MAIN LOCK CYLINDER / CLASS 2 ADDITIONAL LOCK CYLINDER, ESCUTCHEONS WITHOUT PROTECTION (NO RC2 AVAILABLE)

ADJUSTMENT FOR HANDRAIL WITH A BUTTON

AMSTERDAM / MONTREAL HANDRAIL, ELECTRIC STRIKE RECOMMENDED, 1800 mm

AMSTERDAM / MONTREAL HANDRAIL, ELECTRIC STRIKE RECOMMENDED, 1700 mm

AMSTERDAM / MONTREAL HANDRAIL, ELECTRIC STRIKE RECOMMENDED, 1500 mm

AMSTERDAM / MONTREAL HANDRAIL, ELECTRIC STRIKE RECOMMENDED, 1000 mm

AMSTERDAM / MONTREAL HANDRAIL WITH PUSHBUTTON, WITH DOOR LEAF ADJUSTMENT AND ELECTRIC STRIKE, 1800 mm

AMSTERDAM / MONTREAL HANDRAIL WITH PUSHBUTTON, WITH DOOR LEAF ADJUSTMENT AND ELECTRIC STRIKE, 1700 mm

AMSTERDAM / MONTREAL HANDRAIL WITH PUSHBUTTON, WITH DOOR LEAF ADJUSTMENT AND ELECTRIC STRIKE, 1500 mm

AMSTERDAM / MONTREAL HANDRAIL WITH PUSHBUTTON, WITH DOOR LEAF ADJUSTMENT AND ELECTRIC STRIKE, 1000 mm

AMSTERDAM HANDRAIL WITH WIRELESS PUSHBUTTON ELECTRIC STRIKE NECESSARY, 1700 mm

AMSTERDAM HANDRAIL WITH WIRELESS PUSHBUTTON ELECTRIC STRIKE NECESSARY, 1500 mm



















TEDEE SET

EXTRA CHARGES

	OPTIMA 50	OPTIMA 60	THERMO PREMIUM 60	THERMO PREMIUM 75	THERMO PRIME 75
ELECTRIC STRIKE WITH DAY / NIGHT FEATURE RECOMMENDED FOR DOORS WITH HANDRAIL RECOMMENDED WITH POWER SUPPLY UNIT ADDITIONAL ACCESSORIES, SEE p. 97	✓	✓	✓	✓	✓
ELECTRIC STRIKE WITH DAY / NIGHT FEATURE RECOMMENDED FOR DOORS WITH HANDRAIL MOUNTED IN OPTIMA 60 DUO PASSIVE DOOR LEAF	-	✓	-	-	-
FACTORY-FITTED REED SWITCH	✓	✓	✓	✓	✓
DOOR SHORTENING WITHIN THE 0-100mm RANGE (FOR SELECTED DESIGNS)	✓	✓	✓	✓	✓
HIGHER DOOR; TOTAL HEIGHT UP TO 2400mm (AVAILABLE ONLY WITH ALUTHERM 75 DOOR FRAME THERMO PRIME 75 DOORS AND FOR SELECTED DESIGNS)	-	-	-	-	✓
TWO-COLOUR DOOR LEAF	✓	✓	✓	✓	✓
INTERNAL DOOR LEAF REINFORCEMENT FOR SURFACE-MOUNTED CLOSER	✓	✓	✓	✓	✓
DRIP EDGE (RECOMMENDED FOR INWARD OPENED DOORS)	✓	✓	✓	✓	✓
ADJUSTMENT FOR HANDRAIL WITH PUSHBUTTON	-	✓	✓	✓	✓
MOUNTING KIT: FRAME SCREWS, WEDGES, MOUNTING ANCHORS (FRAME SCREWS FOR INSTALLATION IN ORDINARY CONCRETE, CERAMIC BRICK, SOLID SILICATE BRICK, WOOD)	✓	✓	✓	✓	✓







KLAMKI I SZYLDY

OPTIMA 50 OPTIMA 60 THERMO PREMIUM 60 THERMO PREMIUM 75 THERMO PRIME 75

	OPTIMA 50	OPTIMA 60	THERMO PREMIUM 60	THERMO PREMIUM 75	THERMO PRIME 75
 SOFIA LONG ESCUTCHEON HANDLE-HANDLE WITHOUT LOCK CYLINDER PROTECTION	-	-	-	-	✓
 SOFIA LONG ESCUTCHEON SINGLE-SIDED HANDLE WITHOUT LOCK CYLINDER PROTECTION	-	-	-	-	✓
 BERGEN LONG ESCUTCHEON TD200 HANDLE-HANDLE WITH LOCK CYLINDER PROTECTION	-	-	✓	✓	-
 BERGEN LONG ESCUTCHEON TD1000 HANDLE-HANDLE WITH LOCK CYLINDER PROTECTION	-	-	✓	✓	-
 BERGEN LONG ESCUTCHEON SINGLE-SIDED HANDLE WITH LOCK CYLINDER PROTECTION	-	-	✓	✓	-
 BERGEN LONG ESCUTCHEON TD200 KNOB-HANDLE WITH LOCK CYLINDER PROTECTION	-	-	✓	✓	-
 BERGEN LONG ESCUTCHEON TD1000 KNOB-HANDLE WITH LOCK CYLINDER PROTECTION	-	-	✓	✓	-
 BERGEN SPLIT ESCUTCHEON HANDLE-HANDLE	✓	✓	-	-	✓
 BERGEN SPLIT ESCUTCHEON SINGLE-SIDED HANDLE	✓	✓	-	-	✓
 BERGEN SPLIT ESCUTCHEON KNOB-HANDLE	✓	✓	-	-	✓
 BERGEN SPLIT ESCUTCHEON TW300 WITH LOCK CYLINDER PROTECTION	✓	✓	✓	✓	✓
 BERGEN SPLIT ESCUTCHEON TW300 WITHOUT LOCK CYLINDER PROTECTION	✓	✓	✓	✓	✓
 BLOK SPLIT ESCUTCHEON HANDLE-HANDLE	✓	✓	-	-	-
 BLOK SPLIT SCUTCHEON SINGLE-SIDED HANDLE	✓	✓	-	-	-
 BLOK SPLIT SCUTCHEON KNOB-HANDLE	✓	✓	-	-	-
 BLOK SPLIT ESCUTCHEON TW200 WITH LOCK CYLINDER PROTECTION	✓	✓	-	-	-
 BLOK SPLIT ESCUTCHEON TW1000 WITH LOCK CYLINDER PROTECTION	✓	✓	-	-	-
 BLOK SPLIT ESCUTCHEON WITHOUT LOCK CYLINDER PROTECTION	✓	✓	-	-	-

HANDRAILS

		OPTIMA 50	OPTIMA 60	THERMO PREMIUM 60	THERMO PREMIUM 75	THERMO PRIME 75
	AMSTERDAM 1800 mm RECTANGULAR CROSS-SECTION HANDRAIL (PROFILE 40 × 20 mm) ELECTRIC STRIKE RECOMMENDED	✓	✓	✓	✓	✓
	AMSTERDAM 1700 mm RECTANGULAR CROSS-SECTION HANDRAIL (PROFILE 40 × 20 mm) ELECTRIC STRIKE RECOMMENDED	✓	✓	✓	✓	✓
	AMSTERDAM 1500 mm RECTANGULAR CROSS-SECTION HANDRAIL (PROFILE 40 × 20 mm) ELECTRIC STRIKE RECOMMENDED	✓	✓	✓	✓	✓
	AMSTERDAM 1000 mm RECTANGULAR CROSS-SECTION HANDRAIL (PROFILE 40 × 20 mm) ELECTRIC STRIKE RECOMMENDED	✓	✓	✓	✓	✓
	AMSTERDAM 1800 mm RECTANGULAR CROSS-SECTION HANDRAIL WITH PUSHBUTTON (PROFILE 40 × 20 mm) ELECTRIC STRIKE INCLUDED	✓	✓	✓	✓	✓
	AMSTERDAM 1700 mm RECTANGULAR CROSS-SECTION HANDRAIL WITH PUSHBUTTON (PROFILE 40 × 20 mm) ELECTRIC STRIKE INCLUDED	✓	✓	✓	✓	✓
	AMSTERDAM 1500 mm RECTANGULAR CROSS-SECTION HANDRAIL WITH PUSHBUTTON (PROFILE 40 × 20 mm) ELECTRIC STRIKE INCLUDED	✓	✓	✓	✓	✓
	AMSTERDAM 1000 mm RECTANGULAR CROSS-SECTION HANDRAIL WITH PUSHBUTTON (PROFILE 40 × 20 mm) ELECTRIC STRIKE INCLUDED	✓	✓	✓	✓	✓
NEW 	AMSTERDAM 1800 mm RECTANGULAR CROSS-SECTION HANDRAIL WITH WIRELESS PUSHBUTTON (PROFILE 40 × 20 mm) ELECTRIC STRIKE NECESSARY	✓	✓	✓	✓	✓
NEW 	AMSTERDAM 1500 mm RECTANGULAR CROSS-SECTION HANDRAIL WITH WIRELESS PUSHBUTTON (PROFILE 40 × 20 mm) ELECTRIC STRIKE NECESSARY	✓	✓	✓	✓	✓
	MONTREAL 1800 mm CIRCULAR CROSS-SECTION HANDRAIL (PROFILE Ø 35 mm) ELECTRIC STRIKE RECOMMENDED	✓	✓	✓	✓	✓
	MONTREAL 1700 mm CIRCULAR CROSS-SECTION HANDRAIL (PROFILE Ø 35 mm) ELECTRIC STRIKE RECOMMENDED	✓	✓	✓	✓	✓
	MONTREAL 1500 mm CIRCULAR CROSS-SECTION HANDRAIL (PROFILE Ø 35 mm) ELECTRIC STRIKE RECOMMENDED	✓	✓	✓	✓	✓
	MONTREAL 1000 mm CIRCULAR CROSS-SECTION HANDRAIL (PROFILE Ø 35 mm) ELECTRIC STRIKE RECOMMENDED	✓	✓	✓	✓	✓
	MONTREAL 1800 mm CIRCULAR CROSS-SECTION HANDRAIL WITH PUSHBUTTON (PROFILE Ø 35 mm) ELECTRIC STRIKE INCLUDED	✓	✓	✓	✓	✓
	MONTREAL 1700 mm CIRCULAR CROSS-SECTION HANDRAIL WITH PUSHBUTTON (PROFILE Ø 35 mm) ELECTRIC STRIKE INCLUDED	✓	✓	✓	✓	✓
	MONTREAL 1500 mm CIRCULAR CROSS-SECTION HANDRAIL WITH PUSHBUTTON (PROFILE Ø 35 mm) ELECTRIC STRIKE INCLUDED	✓	✓	✓	✓	✓
	MONTREAL 1000 mm CIRCULAR CROSS-SECTION HANDRAIL WITH PUSHBUTTON (PROFILE Ø 35 mm) ELECTRIC STRIKE INCLUDED	✓	✓	✓	✓	✓
NEW 	ROSTOCK 2000 mm RECTANGULAR CROSS-SECTION HANDRAIL (PROFILE 40 × 20 mm) ONLY FOR OUTWARD-OPENING DOORS	-	-	✓	✓	✓

ACCESSORIES		OPTIMA 50	OPTIMA 60	THERMO PREMIUM 60	THERMO PREMIUM 75	THERMO PRIME 75
	WIDE-ANGLE VIEWER 50/80	✓	✓	✓	✓	✓
	4.3" ELECTRONIC VIEWER	✓	✓	✓	✓	✓
	2,4" ELECTRONIC VIEWER	✓	✓	✓	✓	✓
	ACCESS CONTROL NUMERIC KEYPAD	✓	✓	✓	✓	✓
	BUFFER POWER SUPPLY UNIT AWZG2 - 12V; RECOMMENDED FOR DOORS WITH ELECTRIC STRIKE	✓	✓	✓	✓	✓
	SWITCHING POWER SUPPLY PSC12015; RECOMMENDED FOR DOORS WITH ELECTRIC STRIKE	✓	✓	✓	✓	✓
	LOWER LOCKING PLATE	✓	✓	-	-	-
	INTEGRATED CLOSER	-	-	✓	✓	-
	CLOSER GT 1500 STANDARD	✓	✓	✓	✓	✓
	CLOSER GT 1500 INTERLOCK	✓	✓	✓	✓	✓
	ALUMINUM DECORATIVE CAPS FOR HINGES	✓	✓	✓	✓	✓
	OPTIMA ALUMINUM THRESHOLD 20 mm	✓	✓	-	-	-
	THERMO PRIME, THERMO PREMIUM WARM ALUMINIUM THRESHOLD 20 mm	-	-	✓	✓	✓
	DRIP CAP MATCHING THE COLOUR OF THE DOOR LEAF	✓	✓	✓	✓	✓

OPTIONAL EQUIPMENT

GERDA®

ACCESSORIES

OPTIMA 50 OPTIMA 60 THERMO PREMIUM 60 THERMO PREMIUM 75 THERMO PRIME 75

	PERFOTHERM, DUOTHERM DOOR FRAMES STEEL-WOODEN SIDE EXTENSION 30 mm	✓	✓	✓	✓	-
	PERFOTHERM, DUOTHERM DOOR FRAMES STEEL-WOODEN SIDE EXTENSION 60 mm	✓	✓	✓	✓	-
	ALUTHERM PRIME DOOR FRAME ALUMINUM SIDE EXTENSION 25 mm	-	✓	✓	✓	✓
	ALUTHERM PRIME DOOR FRAME ALUMINUM SIDE EXTENSION 33 mm	-	✓	✓	✓	✓
	ALUTHERM PRIME DOOR FRAME ALUMINUM SIDE EXTENSION 44 mm	-	✓	✓	✓	✓
	ALUTHERM PRIME DOOR FRAME ALUMINUM SIDE EXTENSION 55 mm	-	✓	✓	✓	✓
	ALUTHERM PRIME DOOR FRAME ALUMINUM SIDE EXTENSION 108 mm	-	✓	✓	✓	✓
	HARDENED EXPANDED POLYSTYRENE SUB THRESHOLD (EXTENSION) 33 mm 70 mm 100 mm 130 mm 160 mm 190 mm 220 mm 250 mm	✓	✓	✓	✓	✓
	DOOR MAINTENANCE AGENT 1000 ml	✓	✓	✓	✓	✓
	LOCK AND CYLINDER MAINTENANCE AGENT 25 ml	✓	✓	✓	✓	✓
	LOCK AND CYLINDER MAINTENANCE AGENT 100 ml	✓	✓	✓	✓	✓
	LOCK AND CYLINDER MAINTENANCE AGENT 400 ml	✓	✓	✓	✓	✓
	GERDA INOX-1, INOX-2 STAINLESS STEEL CLEANING AGENTS SET 2 X 750 ml	✓	✓	✓	✓	✓
	GERDA RESIST ULTRA INSULATION DUO TAPES	✓	✓	✓	✓	✓

OPTIMA 50

SIZE	MAIN LOCK	ADDITIONAL LOCK	KEYS QUANTITY	CYLINDER CLASS
30/45	DRIVER	-	3	2
30/45	-	DRIVER / KNOB	3	2
30/45 ; 30/45	DRIVER	DRIVER / KNOB	5 + INSTALLER KEYS	5
30/45 ; 45/30	DRIVER	DRIVER / KNOB	5 + INSTALLER KEYS	6

OPTIMA 60 RC2/RC3

SIZE	MAIN LOCK	ADDITIONAL LOCK	KEYS QUANTITY	CYLINDER CLASS
35/55; 35/55	GEAR	DRIVER / KNOB WITH LOCK CYLINDER PROTECTION	5 + INSTALLER KEYS	5
35/55; 30/50	GEAR	DRIVER / KNOB WITHOUT LOCK CYLINDER PROTECTION	5 + INSTALLER KEYS	5
35/55; 35/55	GEAR	DRIVER / KNOB WITH LOCK CYLINDER PROTECTION	5 + INSTALLER KEYS	6
35/55; 30/50	GEAR	DRIVER / KNOB WITHOUT LOCK CYLINDER PROTECTION	5 + INSTALLER KEYS	6

THERMO PREMIUM 60 RC2/RC3

SIZE	MAIN LOCK	ADDITIONAL LOCK	KEYS QUANTITY	CYLINDER CLASS
35/50	-	-	5 + INSTALLER KEYS	5
35/50 ; 50/35	-	DRIVER / KNOB WITHOUT LOCK CYLINDER PROTECTION	3	2
35/50 ; 50/35	DRIVER / GEAR	DRIVER / KNOB WITH LOCK CYLINDER PROTECTION	5 + INSTALLER KEYS	5
35/55 ; 30/50	DRIVER / GEAR	DRIVER / KNOB WITHOUT LOCK CYLINDER PROTECTION	5 + INSTALLER KEYS	5
35/50 ; 35/55	DRIVER / GEAR	DRIVER / KNOB WITH LOCK CYLINDER PROTECTION	5 + INSTALLER KEYS	6
35/55 ; 30/50	DRIVER / GEAR	DRIVER / KNOB WITHOUT LOCK CYLINDER PROTECTION	5 + INSTALLER KEYS	6

THERMO PREMIUM 75 RC2/RC3

SIZE	MAIN LOCK	ADDITIONAL LOCK	KEYS QUANTITY	CYLINDER CLASS
45/55	GEAR	-	5 + INSTALLER KEYS	5
45/55 ; 55/45	-	DRIVER / KNOB	3	2
45/55 ; 55/45	GEAR	DRIVER / KNOB	5 + INSTALLER KEYS	5
45/55 ; 55/45	GEAR	DRIVER / KNOB	5 + INSTALLER KEYS	6

THERMO PRIME 75 RC2

SIZE	MAIN LOCK	ADDITIONAL LOCK	KEYS QUANTITY	CYLINDER CLASS
45/55	DRIVER	HANDLE / HANDLE INWARDS	5 + INSTALLER KEYS	5
30/55	DRIVER	HANDLE / HANDRAIL INWARDS	5 + INSTALLER KEYS	5
45/55	DRIVER	HANDLE / HANDLE OUTSIDE	5 + INSTALLER KEYS	5
30/45	DRIVER	HANDLE / HANDRAIL OUTSIDE	5 + INSTALLER KEYS	5
G55/45	DRIVER	HANDLE / HANDLE INWARDS	5 + INSTALLER KEYS	5
G55/35	DRIVER	HANDLE / HANDRAIL INWARDS	5 + INSTALLER KEYS	5
G50/50	DRIVER	HANDLE / HANDLE OUTSIDE	5 + INSTALLER KEYS	5
G50/35	DRIVER	HANDLE / HANDRAIL OUTSIDE	5 + INSTALLER KEYS	5
45/55	DRIVER	HANDLE / HANDLE INWARDS	5 + INSTALLER KEYS	6
30/55	DRIVER	HANDLE / HANDRAIL INWARDS	5 + INSTALLER KEYS	6
45/55	DRIVER	HANDLE / HANDLE OUTSIDE	5 + INSTALLER KEYS	6
30/45	DRIVER	HANDLE / HANDRAIL OUTSIDE	5 + INSTALLER KEYS	6
G55/45	DRIVER	HANDLE / HANDLE INWARDS	5 + INSTALLER KEYS	6
G55/35	DRIVER	HANDLE / HANDRAIL INWARDS	5 + INSTALLER KEYS	6
G50/50	DRIVER	HANDLE / HANDLE OUTSIDE	5 + INSTALLER KEYS	6
G50/35	DRIVER	HANDLE / HANDRAIL OUTSIDE	5 + INSTALLER KEYS	6

DOUBLE LOCK DOORS: MAIN LOCK – KEY/KEY LOCK CYLINDER; ADDITIONAL LOCK – KEY/KNOB LOCK CYLINDER.
SINGLE LOCK DOORS: MAIN LOCK – KEY/KEY LOCK CYLINDER OR KEY/KNOB LOCK CYLINDER.

DOOR AND DOOR FRAME DIMENSIONS

GERDA®

THERMO PRIME / THERMO PREMIUM DOOR LEAF SIZE [mm]

WIDTH

SIZE	DOOR MODEL	DOOR LEAF WIDTH, NARROW SIDE (Sp)	DOOR LEAF WIDTH, BROAD SIDE (Ss)
80	THERMO PRIME / THERMO PREMIUM	812	842
90N		882	912
90E		925	955
100E		1025	1055

HEIGHT

DOOR MODEL	HEIGHT	DOOR LEAF HEIGHT, NARROW SIDE (Hs)	DOOR LEAF HEIGHT, BROAD SIDE (Hp)
T. PRIME / T.PREMIUM	2087	2009	2039
THERMO PRIME	2100	2022	2052
	2150	2072	2102
	2200	2122	2152
	2250	2172	2202
	2300	2222	2252
	2350	2272	2302
	2400	2322	2352

ALUTHERM PRIME / ALUTHERM PREMIUM / DUOTHERM DOOR FRAME SIZE [mm]

SIZE	DOOR FRAME MODEL	TOTAL DOOR FRAME WIDTH (Sc)	RECOMMENDED MOUNTING CUT-OUT WIDTH (Sm)*	TOTAL DOOR FRAME HEIGHT (Hc)***	RECOMMENDED MOUNTING CUT-OUT HEIGHT FROM LEVEL 0 (Hm)**
80	DUOTHERM	896	916	2076	2086
90 N		966	986		
90 E		1009	1029		
100 E		1109	1129		
80	ALUTHERM	918	938	STANDARD 2087 CUSTOM****	STANDARD 2097 CUSTOM****
90 N		988	1008		
90 E		1031	1051		
100 E		1131	1151		

* INCLUDES MOUNTING CLEARANCE OF 10 mm PER SIDE

** INCLUDES MOUNTING CLEARANCE OF 10 mm

*** FOR DOORS WITH INTEGRATED CLOSER TOTAL HEIGHT OF THE FRAME +3.5 mm

**** THERMO PRIME ONLY

GERDA® DOOR AND DOOR FRAME DIMENSIONS

THERMO PRIME 75 / THERMO PREMIUM 75

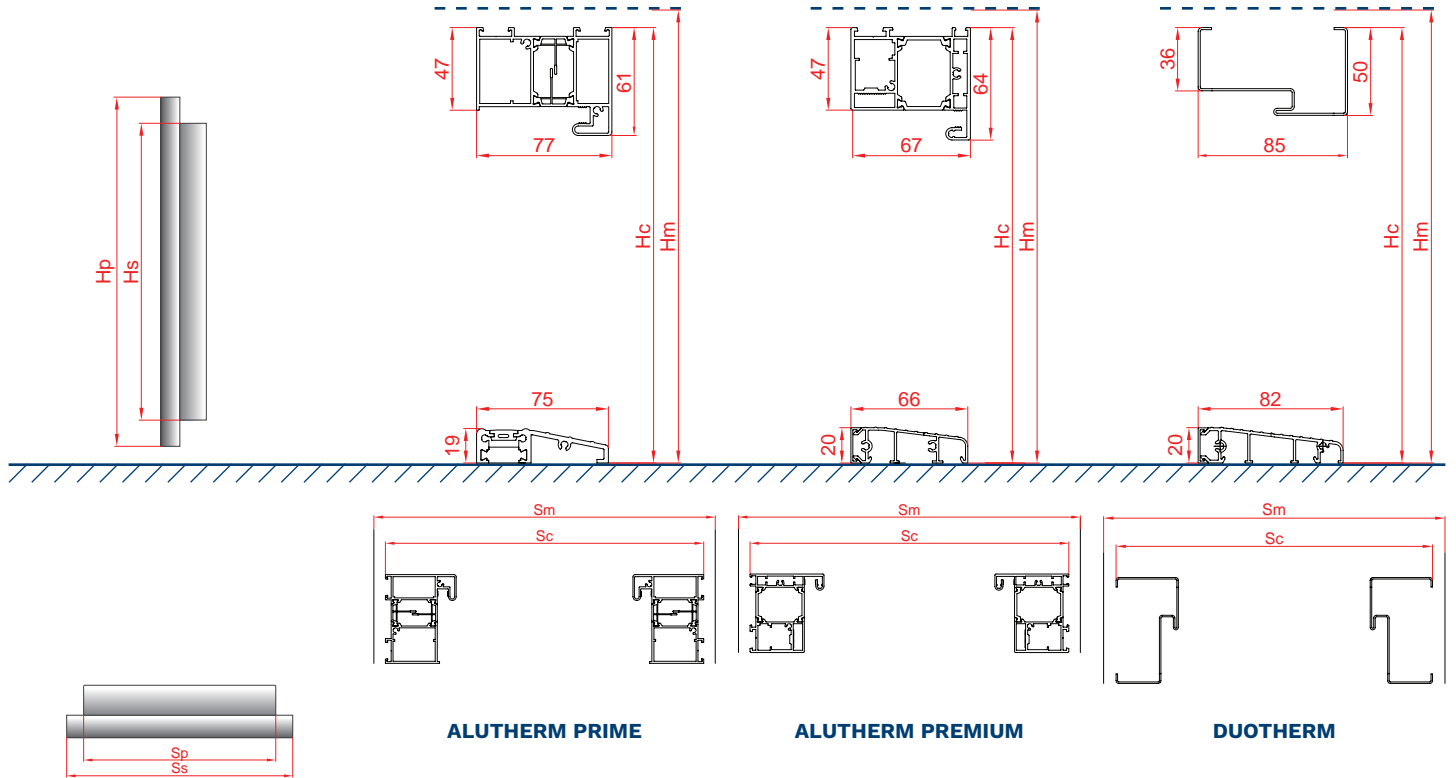

THERMO PREMIUM 60

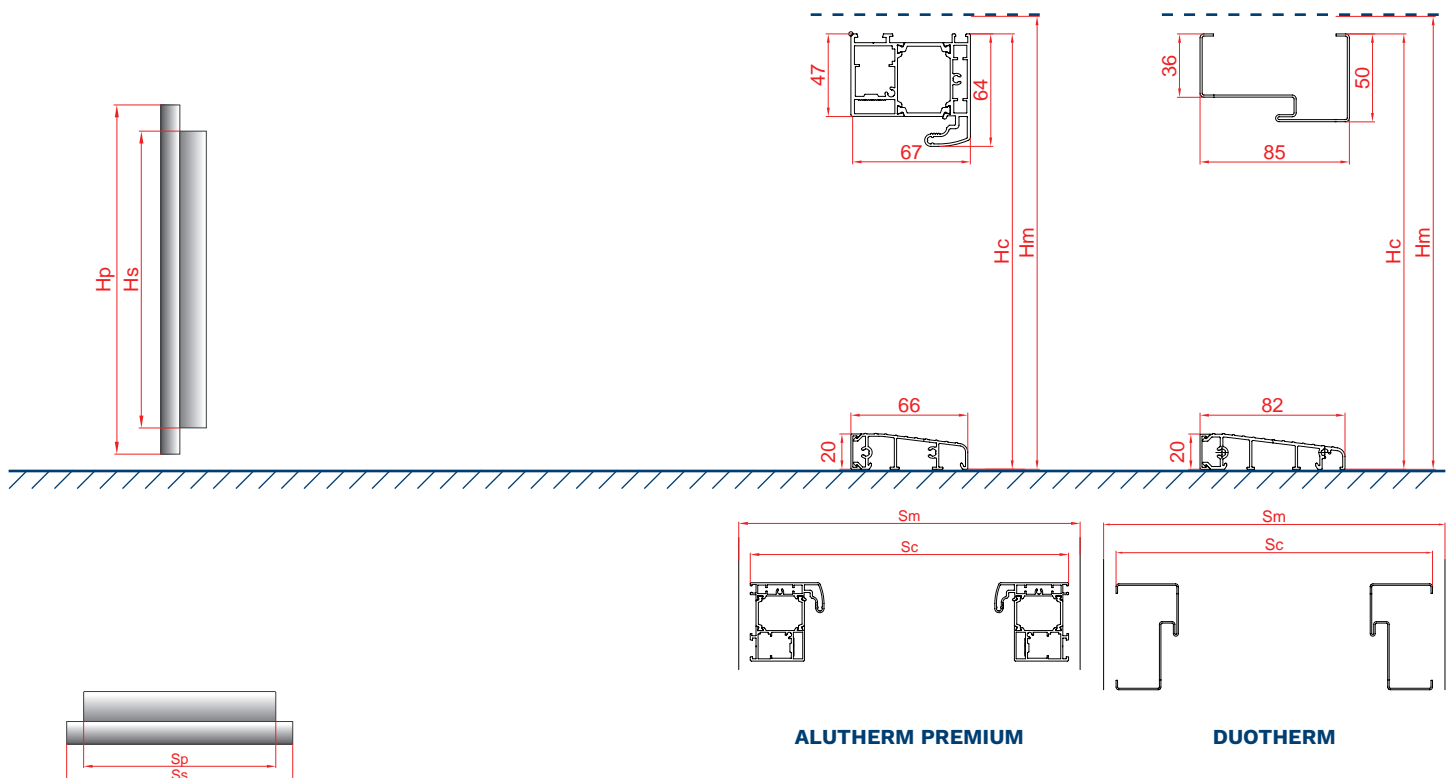

AVOID INSTALLING DARK COLOUR DOORS IN AREAS EXPOSED TO DIRECT AND LONG-TERM SUNLIGHT. DOOR INSTALLED AS EXTERIOR ENTRANCE DOOR AT SITES DIRECTLY EXPOSED TO WEATHER CONDITIONS (RAIN, WIND, ETC.) SHOULD OPEN OUTWARDS. IF MOUNTED AS AN EXTERIOR ENTRANCE DOOR, A ROOFING IS REQUIRED.

DOOR AND DOOR FRAME DIMENSIONS



OPTIMA DOOR LEAF SIZE [mm]

SIZE	DOOR MODEL	DOOR LEAF WIDTH, NARROW SIDE (Sp)	DOOR LEAF WIDTH, BROAD SIDE (Ss)	DOOR LEAF HEIGHT, NARROW SIDE (Hs)	DOOR LEAF HEIGHT, BROAD SIDE (Hp)
80N	OPTIMA	782	812	2023	2038,5
80		812	842		
90N		882	912		
90E		925	955		
100E		1025	1055		
30	OPTIMA DUO 60	257	287		
40		357	387		
50		457	487		

ALUTHERM OPTIMA, PERFOTHERM, FB DOOR FRAME SIZE [mm]

SIZE	DOOR FRAME MODEL	TOTAL DOOR FRAME WIDTH (Sc)	RECOMMENDED MOUNTING CUT-OUT WIDTH (Sm)*	TOTAL DOOR FRAME HEIGHT (Hc)	RECOMMENDED MOUNTING CUT-OUT HEIGHT FROM LEVEL 0 (Hm)**
80N	PERFOTHERM, FB	866	886	2076	2086
80		896	916		
90 N		966	986		
90 E		1009	1029		
100 E		1109	1129		
80	ALUTHERM	918	938	2087	2097
90 N		988	1008		
90 E		1031	1051		
100 E		1131	1151		

* INCLUDES MOUNTING CLEARANCE OF 10mm PER SIDE

** INCLUDES MOUNTING CLEARANCE OF 10mm

GERDA® DOOR AND DOOR FRAME DIMENSIONS

OPTIMA 60

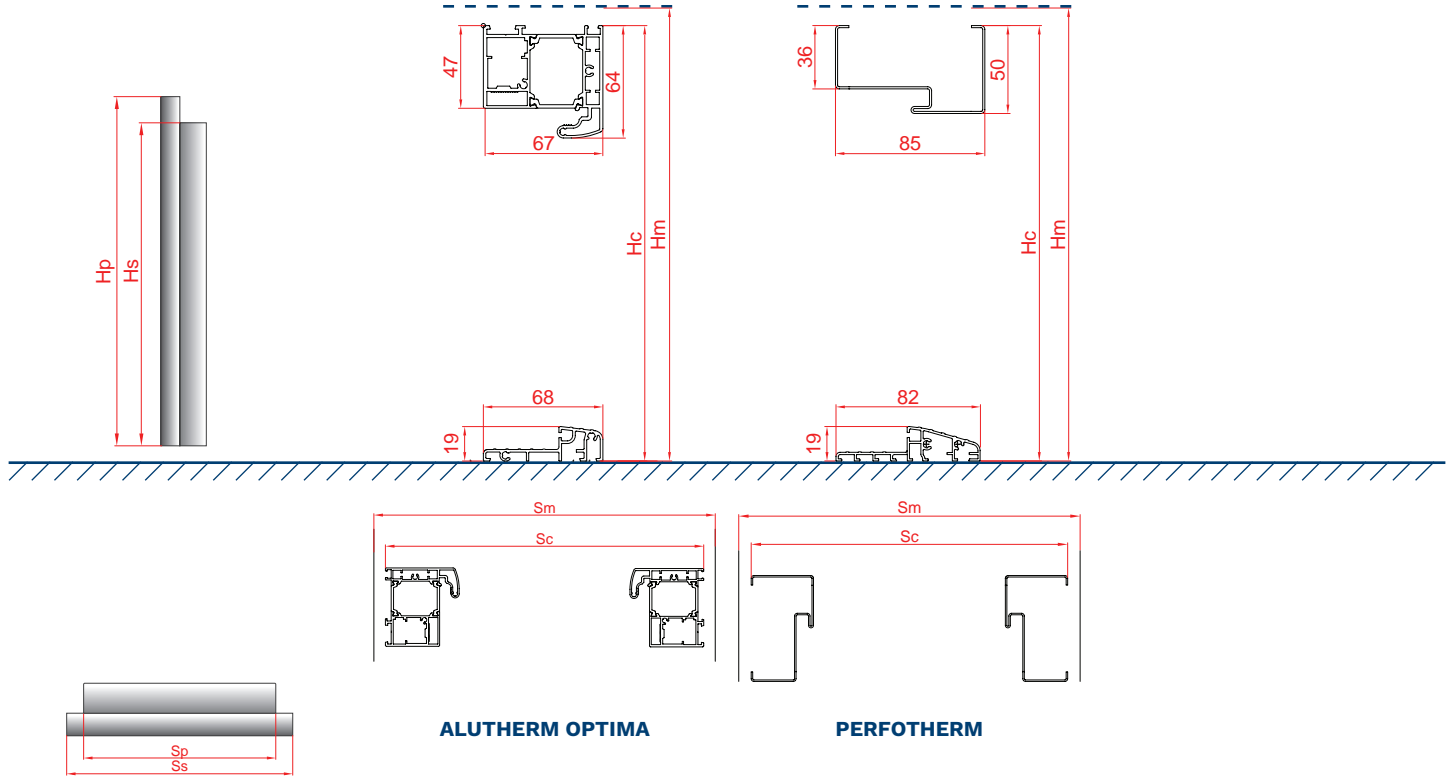

OPTIMA 50

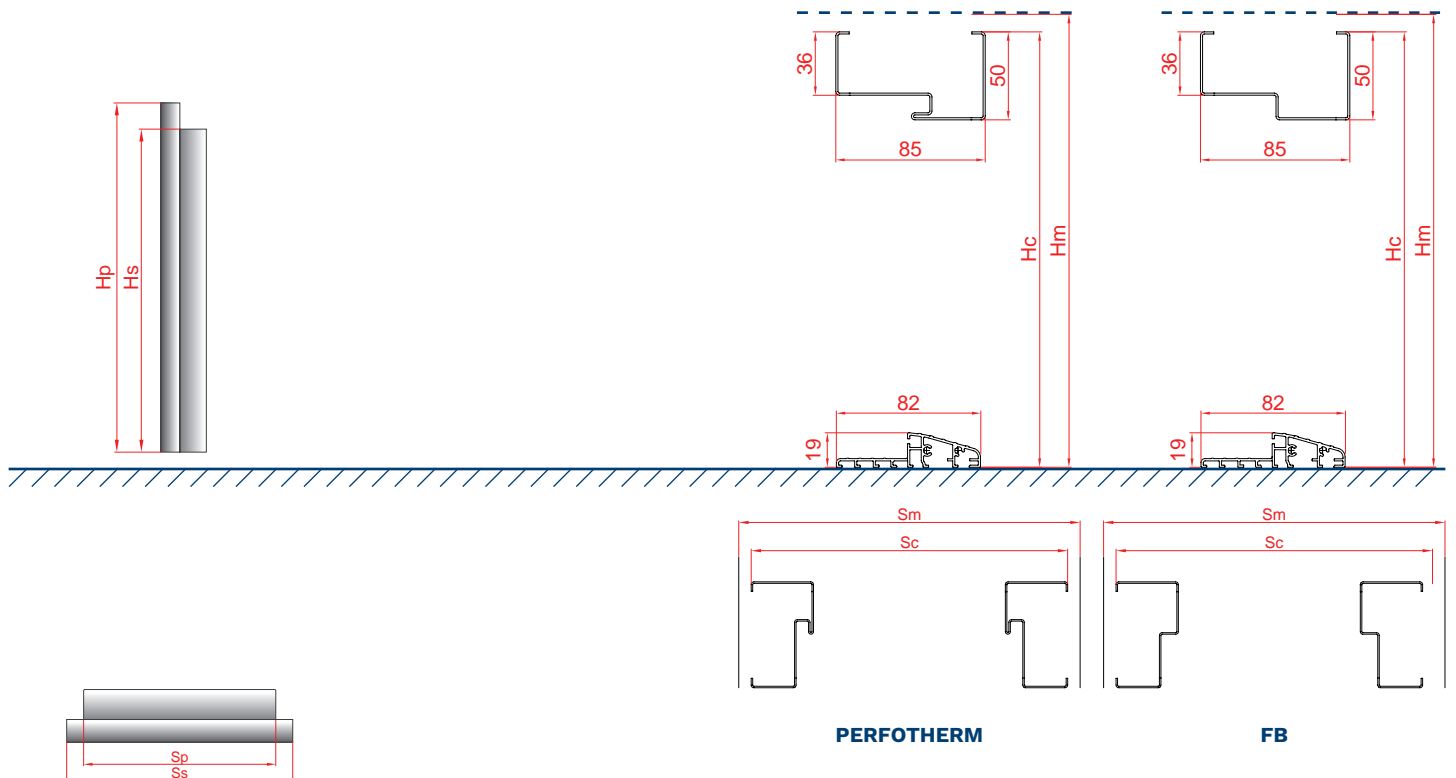

AVOID INSTALLING DARK COLOUR DOORS IN AREAS EXPOSED TO DIRECT AND LONG-TERM SUNLIGHT. DOOR INSTALLED AS EXTERIOR ENTRANCE DOOR AT SITES DIRECTLY EXPOSED TO WEATHER CONDITIONS (RAIN, WIND, ETC.) SHOULD OPEN OUTWARDS. IF MOUNTED AS AN EXTERIOR ENTRANCE DOOR, A ROOFING IS REQUIRED.

DOOR AND DOOR FRAME DIMENSIONS



FN DOOR FRAME SIZE FOR OPTIMA 50 DOOR [mm]

SIZE	DOOR FRAME MODEL	TOTAL DOOR FRAME WIDTH (Sc1)	TOTAL DOOR FRAME WIDTH (Sc2)	RECOMMENDED MOUNTING CUT-OUT WIDTH (Sm)*	TOTAL DOOR FRAME HEIGHT (Hc1)	TOTAL DOOR FRAME HEIGHT (Hc2)	RECOMMENDED MOUNTING CUT-OUT HEIGHT FROM "0" (Hm)**
80N	FN	862	797	817	2075	2041	2051
80		892	827	847			
90N		962	897	917			
90E		1005	940	960			
100E		1105	1040	1060			

ALUTHERM OPTIMA, PERFOTHERM DOOR FRAME SIZE FOR OPTIMA 60 DUO DOOR [mm]

SIZE	ALUTHERM		PERFOTHERM		ALUTHERM		PERFOTHERM	
	TOTAL DOOR FRAME WIDTH (Sc)	RECOMMENDED MOUNTING CUT-OUT WIDTH (Sm)*	TOTAL DOOR FRAME WIDTH (Sc)	RECOMMENDED MOUNTING CUT-OUT WIDTH (Sm)*	TOTAL DOOR FRAME HEIGHT (Hc)	RECOMMENDED MOUNTING CUT-OUT HEIGHT FROM LEVEL 0 (Hm)**	TOTAL DOOR FRAME HEIGHT (Hc)	RECOMMENDED MOUNTING CUT-OUT HEIGHT FROM LEVEL 0 (Hm)**
80	918	938	896	916	2087	2097	2076	2086
80+30	1209	1229	1187	1207				
80+40	1309	1329	1287	1307				
80+50	1409	1429	1387	1407				
90 E	1031	1051	1009	1029				
90 E +30	1322	1342	1300	1320				
90 E +40	1422	1442	1400	1420				
90 E +50	1522	1542	1500	1520				
100 E	1131	1151	1109	1129				
100 E +30	1422	1442	1400	1420				
100 E +40	1522	1542	1500	1520				
100 E +50	1622	1642	1600	1620				

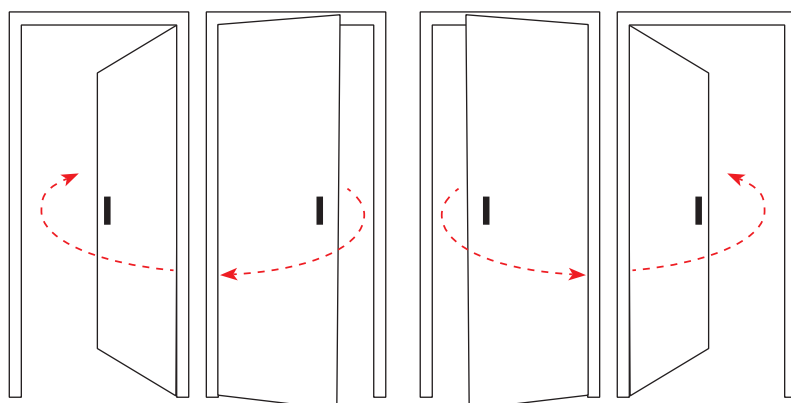

LEFT-HAND DOOR

RIGHT-HAND DOOR

* INCLUDES MOUNTING CLEARANCE OF 10mm PER SIDE
 ** INCLUDES MOUNTING CLEARANCE OF 10mm

GERDA® DOOR AND DOOR FRAME DIMENSIONS

OPTIMA 50

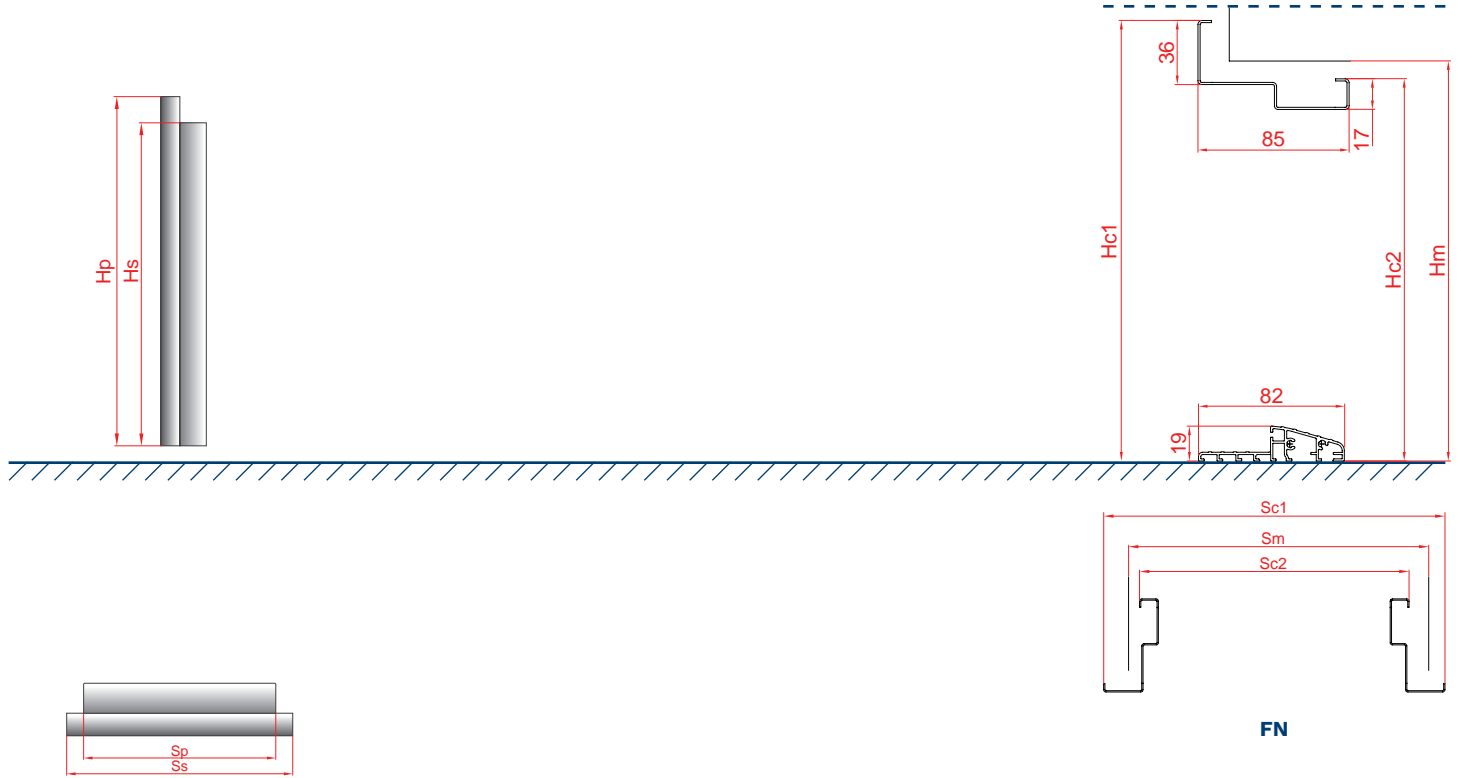

OPTIMA 60 DUO

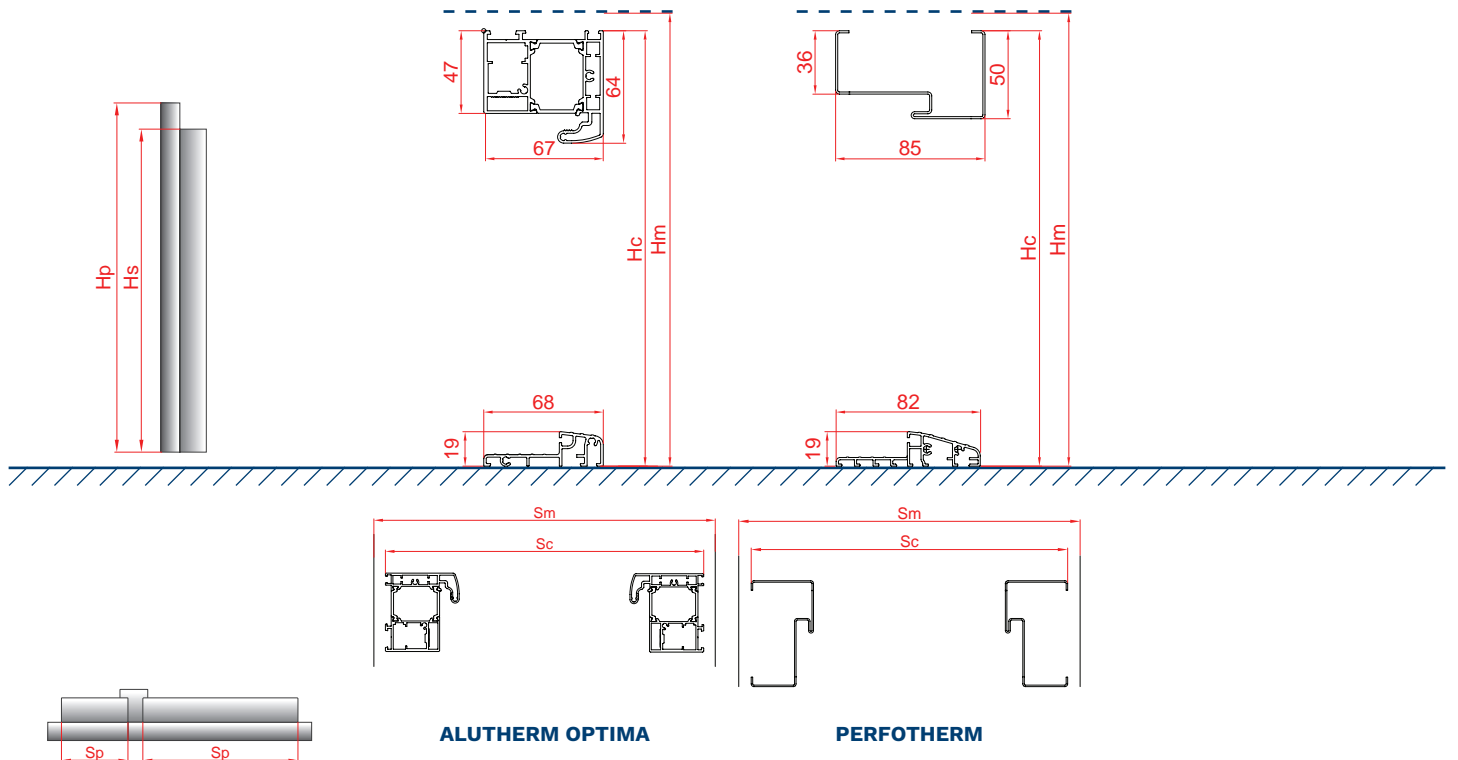

AVOID INSTALLING DARK COLOUR DOORS IN AREAS EXPOSED TO DIRECT AND LONG-TERM SUNLIGHT. DOOR INSTALLED AS EXTERIOR ENTRANCE DOOR AT SITES DIRECTLY EXPOSED TO WEATHER CONDITIONS (RAIN, WIND, ETC.) SHOULD OPEN OUTWARDS. IF MOUNTED AS AN EXTERIOR ENTRANCE DOOR, A ROOFING IS REQUIRED.

INSPIRATIONS FROM THE COMPLETED PROJECTS

GERDA®



GERDA[®] INSPIRATIONS FROM THE COMPLETED PROJECTS



GERDA[®]

GERDA Dealer in Canada:

ENTRY DOORS TORONTO Inc.

Showroom address: 7321 Victoria Park Ave., unit 20,
Markham ON L3R 2Z8 Canada

Phone: (647) 449-9047

Email: info@entrydoors-toronto.com

Web: www.entrydoors-toronto.com